

ABB-free@home[®] System Manual

1	System requirements	5
1.1	User interface	5
1.2	free@home app	5
1.3	Home network	5
2	Performance features	6
2.1	Device versions	6
2.2	Limits of performance	7
3	Planning and Installation	8
3.1	Twisted pair version.....	8
3.1.1	System Access Point	8
3.1.2	Power supply	8
3.1.3	Installation of actuators	9
3.1.4	Topology of line participants	10
3.1.5	Lengths and distances of lines	11
3.1.6	Bus line	11
3.2	Wireless version	12
3.2.1	System Access Point	12
3.2.2	Power supply	12
3.2.3	Installation of actuators	13
3.2.4	System features	13
	Mesh network	14
	Transmission range	15
	Interference of radio signal	16
3.3	Planning of the System Access Point.....	19
3.4	Creating a plan for devices	22
4	Commissioning	23
4.1	Prerequisites.....	23
4.2	Establishing the connection to user interface of the System Access Point	23
4.3	Basic settings	27
4.4	User rights	28
4.5	Setup of the main menu	29
4.6	Setup of the working area.....	30
4.7	Creating the house structure	30
4.8	Allocating devices to rooms.....	32
4.8.1	Identification	33
4.8.2	Specifying a name	35
4.9	Linking sensors and actuators	36
4.9.1	Switching options	37
4.10	Time control.....	37
4.10.1	Time profiles	37
4.10.2	Timeline.....	39
4.10.3	List view	40
4.11	Actions.....	41
4.11.1	Parts of an action	42
4.11.2	Time diagram	43
4.11.3	Examples of possible actions:.....	44

4.12	Panels.....	47
4.13	Coupling of wireless devices with the System Access Point	48
	Resetting the wireless device to the factory settings	48
4.14	myABB Living Space®	49
5	Types of Devices	52
5.1	Sensors and control elements	52
5.1.1	Control elements	52
	Button function	54
	LED as light for orientation.....	55
	LED as status display	56
	Parameter settings of 1/1gang sensor/switch actuator.....	57
	Parameter settings of 2/1gang sensor/switch actuator.....	58
	Parameter settings of 2/2gang sensor/switch actuator.....	58
	Parameter settings of 1/1gang sensor/dimming actuator	59
	Parameter settings of 2/1gang sensor/dimming actuator	60
	Parameter settings of 1/1gang sensor/blind actuator	61
	Parameter settings of 2/1gang sensor/blind actuator	62
	Parameter settings of 1gang sensor unit.....	63
	Parameter settings of 2gang sensor unit.....	63
5.1.2	Movement detector	64
	Parameter settings of movement detectors/switch actuators, 1gang	67
	Parameter settings of movement detector (sensor).....	67
5.1.3	Room temperature controller	68
	Parameter settings of room temperature controller	71
5.1.4	Displays.....	72
5.2	Binary inputs.....	75
5.3	Weather station	79
5.3.1	Allocation	80
5.3.2	Linking sensors of the weather station	81
5.4	Actuators	82
5.4.1	Switch actuators.....	82
5.4.2	Dimming actuators	83
5.4.3	Blind actuators	84
5.4.4	Heating actuators	85
5.5	System Access Point.....	86
5.5.1	Identification.....	86
5.5.2	Identification of wireless devices	86
5.5.3	Network functions	87
5.5.4	Control and display elements.....	88
5.5.5	Master reset without access to the Web interface	88
5.5.6	Additional general settings in the System Access Point.....	89
6	Device Functions	91
7	Functional system extensions	94
7.1	Phillips Hue.....	94
7.1.1	Phillips Hue integration	94
7.1.2	Phillips Hue setup	94
7.1.3	Allocating links	97
7.1.4	Parameters	98
7.1.5	Colour settings	98

7.1.6	Time control	99
7.1.7	Philips Hue parameter settings	99
8	Overview of Product Range	100
8.1	System devices	100
8.2	Displays	101
8.3	Sensors	102
8.4	Sensor/actuator units.....	105
8.5	Actuators	109
8.6	Covers for switch ranges.....	112
8.7	Directory of available covers	113
9	FAQ and Tips.....	116
9.1	Mounting the System Access Point	116
9.1.1	Connection of the CAT wire	116
9.2	Device plan master	117
10	Notes.....	118
11	Index	119

1 System requirements

1.1 User interface

To open the Web-based user interface of the System Access Point you require a computer with a LAN or WLAN network adaptor and an installed Internet browser.

The recommended browsers are:

- Firefox (from version 9)
- Internet Explorer (from version 11)
- Google Chrome
- Safari

1.2 free@home app

For the installation of the free@home app you require a smartphone or tablet with an Android (from 4.0) or iOS (from iOS 7) operating system.

1.3 Home network

To be able to access the free@home app and Internet services (e.g. e-mail) at the same time during standard operation, the System Access Point must be integrated into the existing home network after commissioning. For this, a router with Ethernet or WLAN interface is required.

2 Performance features

The free@home system is both a twisted-pair-based bus system as well as a wireless system for home automation. A combination of both variations is possible.

The free@home system enables the control and automation of lighting, heating, and blinds and also provides integration of the ABB-Welcome® door communication system. Control takes place on site using permanently installed control elements or mobile via the smartphone or tablet.

Functions are allocated only via software; i.e., if the use of a room changes in future, the function of the light switch can also be easily changed.

No special software is required for commissioning. Configuration takes place using the available Internet browser of the computer, or the free free@home app of your smartphone or tablet (Android/iOS).

A free@home system is made up of the following devices:

- a System Access Point,
- a power supply,
- sensors for local operation,
- actuators for switching loads.



NOTE

No separate power supply is required for pure wireless systems.

2.1 Device versions

Up to 64 devices can be installed in a system (power supply is not included).

The following versions of devices are available:

System devices	Sensors	Actuators
System Access Point	Control elements	Switch actuators
Power supply	Panels	Dimming actuators
	Binary inputs	Blind actuators
	Room temperature controller (RTC)	Heating actuators
	Movement detectors	

Table 1: Device versions



NOTE

No separate power supply is required for pure wireless systems.

Sensors and actuators are each available in construction types **flush-mounted**, **pellet** and **rail-mounting**. The devices can be combined as required according to application.

2.2 Limits of performance

The web-based user interface of the System Access Point can be called up and operated simultaneously by several participants (computers and/or mobile devices with the free@home-app). This can, depending on the changes made, lead to losses in performance (the changes take longer to implement). That is why it is recommended to operate the user interface with only 4 participants at the same time.

3 Planning and Installation

The free@home system is both a twisted-pair-based bus system as well as a wireless system for home automation. A combination of both variations is possible.

3.1 Twisted pair version

3.1.1 System Access Point

The System Access Point [01] offers the opportunity for accessing the free@home system with the PC or mobile terminal devices. This allows the functions of the system to be programmed and remote controlled.

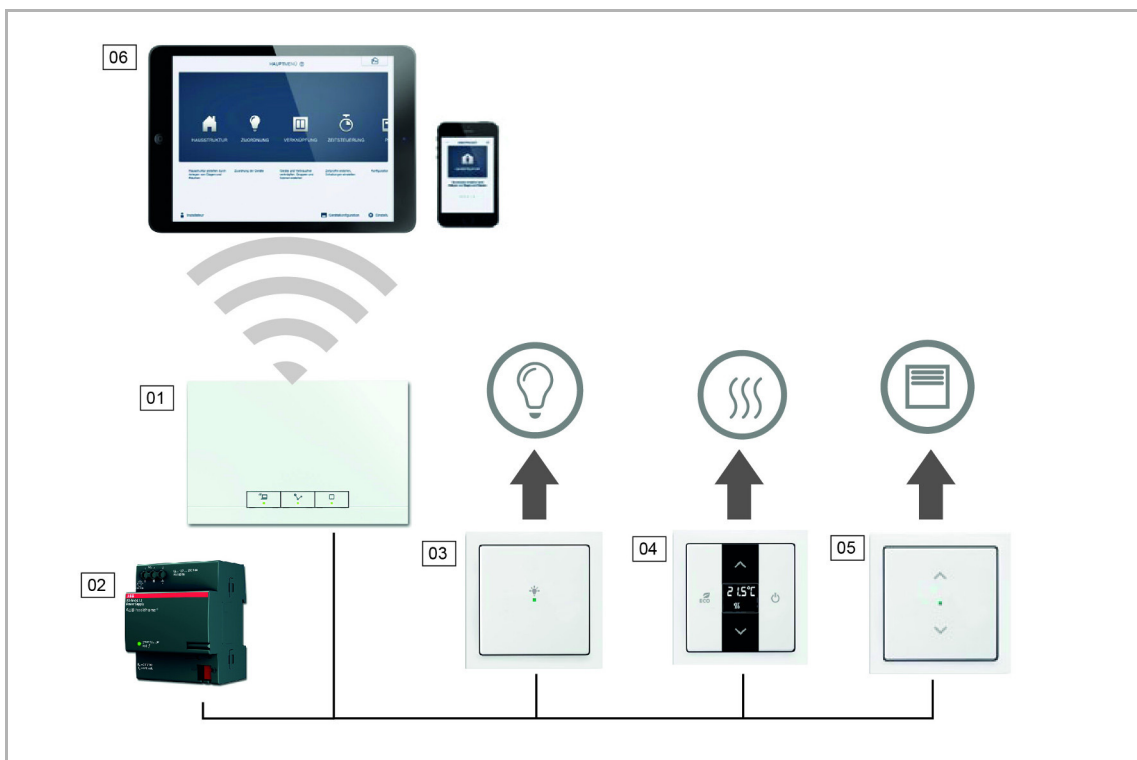

Fig. 1: Plan of twisted pair system

- 01 – System Access Point
- 02 – Power supply
- 03 – Sensor/switching actuator unit
- 04 – Room temperature controller
- 05 – Sensor/blind actuator unit
- 06 – Mobile terminal devices

3.1.2 Power supply

Each system requires a power supply [2] (see Fig. 1). It uses the voltage required by the bus subscribers for supplying the bus communication part of the devices.

3.1.3 Installation of actuators

The free@home system offers both rail-mounting actuators for central installation in the switch cabinet as well as sensor/actuator units for decentralized flush-mounted installation.

Both types of installation can be mixed within the system as desired.

Advantages of the decentralized installation:

- "All-in-one": Sensor and actuator are located in the one device.
- Function does not need programming since sensor and actuator have been pre-configured.
- Usual manner of wiring of the 230 V line.

Advantages of the central installation:

- Inexpensive channel price due to multiple actuators.
- Easy installation of the sensor technology since only the bus line is installed in the flush-mounted box.

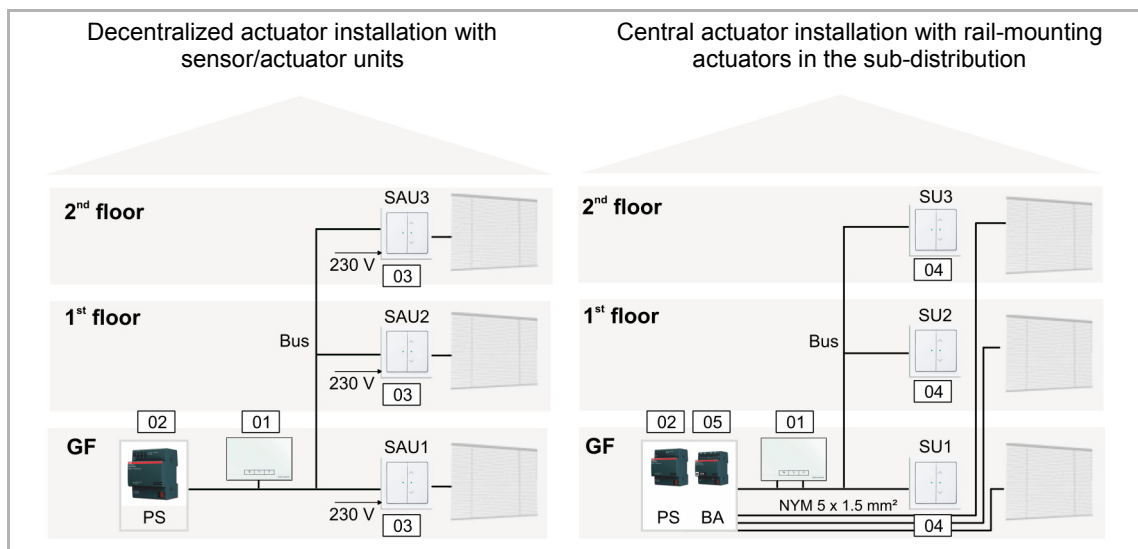

Fig. 2: Planning of the twisted pair actuators

- 01 – System Access Point
- 02 – Power supply (PS)
- 03 – Sensor/blind actuator unit (SAU)
- 04 – Sensor unit (SU)
- 05 – Blind actuator (BA)

3.1.4 Topology of line participants

The free@home system communicates via a data bus. This means that each device must be connected to the bus. Only then can the device communicate with other participants.

Participants

Each free@home device, with the exception of the power supply, counts as a participant. Up to 64 participants can be connected to the bus.



NOTE

Also the System Access Point counts as a participant.

Line topologies

The free@home bus line can be installed in almost any manner desired.

- Mixing the line topologies (linear, star and tree) is permitted.
- Only rings must not be set up.
- No terminal resistors are required.

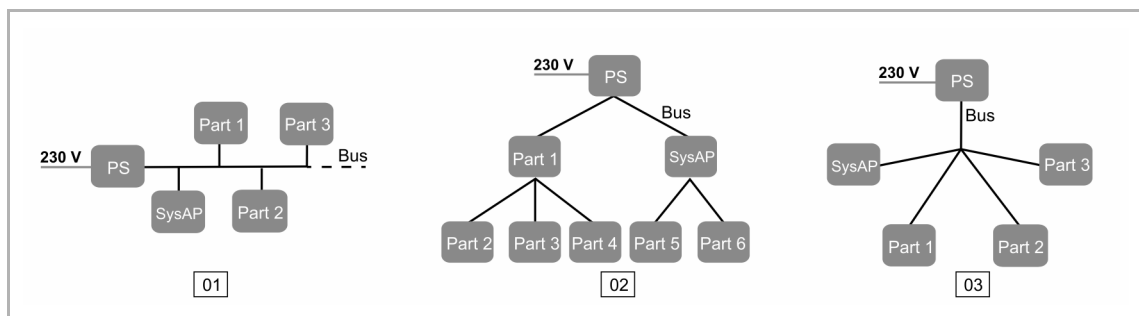

Fig. 3: Possible topologies

01 – Linear topology

02 – Tree topology

03 – Star topology

PS – Power supply

Part – Participant

SysAP – System Access Point

3.1.5 Lengths and distances of lines

- [A] The lengths of lines within a line are limited to a total length of max. 1,000 m.
- [B] The distance between power supply and the last participant: max. 350 m.
- [C] The distance between two participants: max. 700 m.

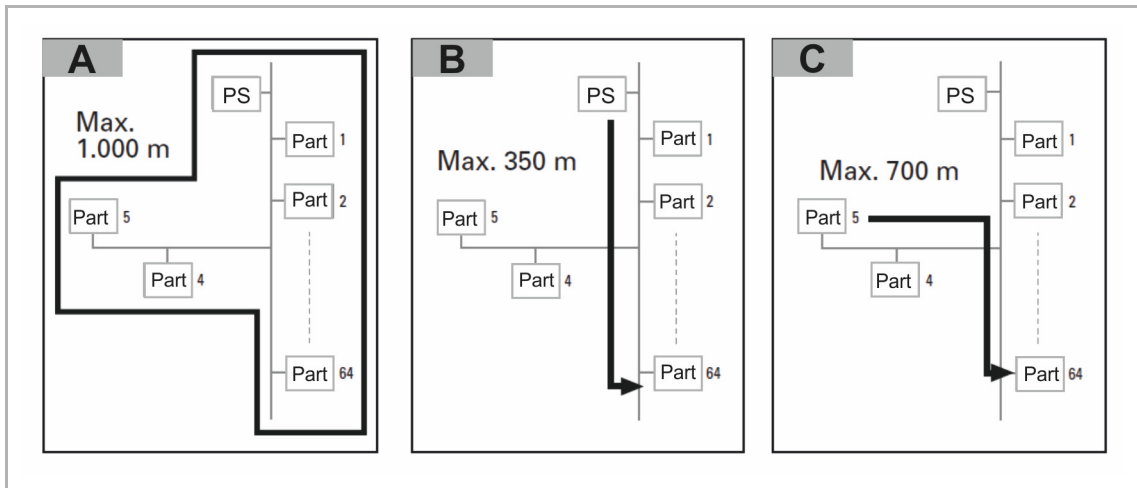

Fig. 4: Lengths and distances of lines

PS – Power supply
Part – Participant

3.1.6 Bus line

The bus line leads to the participants.

- A KNX-certified bus line (J-Y(ST)Y 2x2x0.8) is to be used.
- Aside from the necessary physical characteristics (number of wires, cross-section, insulating voltage, etc.) the bus line can be differentiated immediately from other low-current lines.



NOTE

Applications and devices should be permanently installed to prevent their easy removal and thereby allow access of unauthorized persons to the system.

- The cable ends should not be visible or project out from the wall, neither inside nor outside the building.

Bus lines in outdoor areas represent an increased security risk. Here the physical access to the bus cable should be made exceptionally difficult.

- If possible, no network lines should be laid outdoors.
- Outdoor devices should be protected against unauthorized dismantling.

3.2 Wireless version

3.2.1 System Access Point

The System Access Point [01] offers the opportunity for accessing the free@home system with the PC or mobile terminal devices. This allows the functions of the system to be programmed and remote controlled.

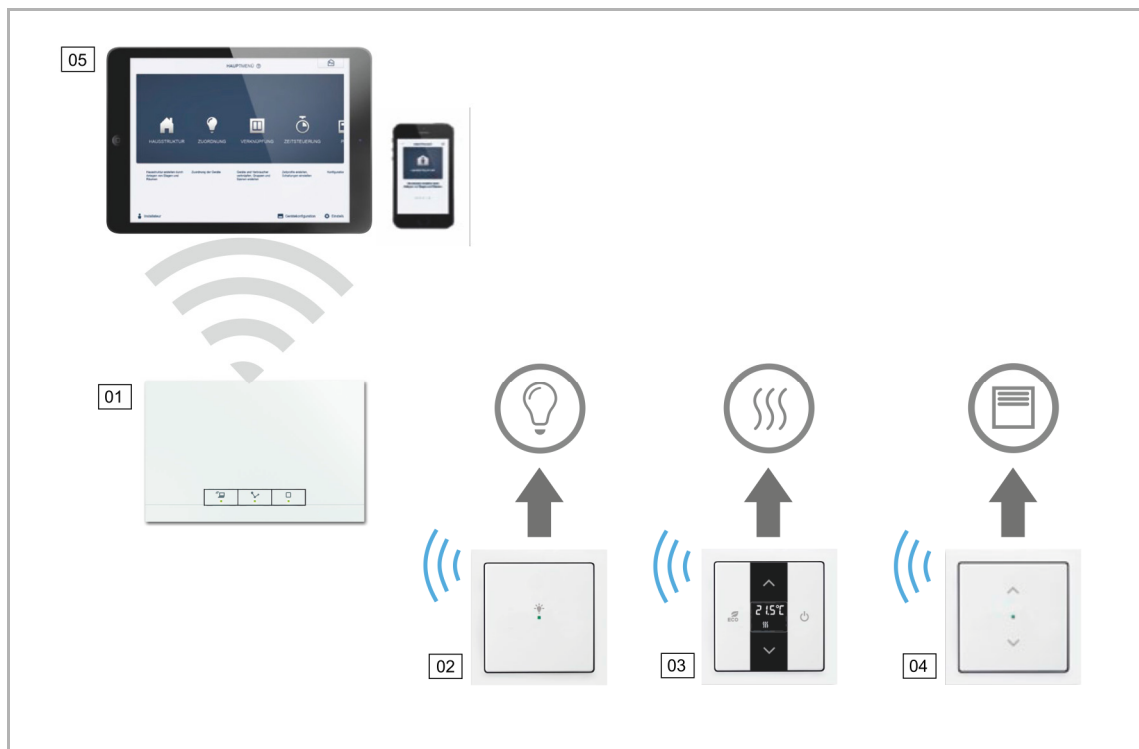

Fig. 5: Plan of wireless system

- 01 – System Access Point
- 02 – Sensor/switching actuator unit
- 03 – Room temperature controller
- 04 – Sensor/blind actuator unit
- 05 – Mobile terminal devices

3.2.2 Power supply

No separate power supply is required for pure wireless systems. The power is supplied directly from the 230 V network via the connection of the devices.

3.2.3 Installation of actuators

Sensor/actuator units are available for the free@home system for decentralized flush-mounted installation.

Advantages of the decentralized installation:

- "All-in-one": sensor and actuator are located in the one device.
- Function does not need programming since sensor and actuator have been pre-configured.
- Usual manner of wiring of the 230 V line.

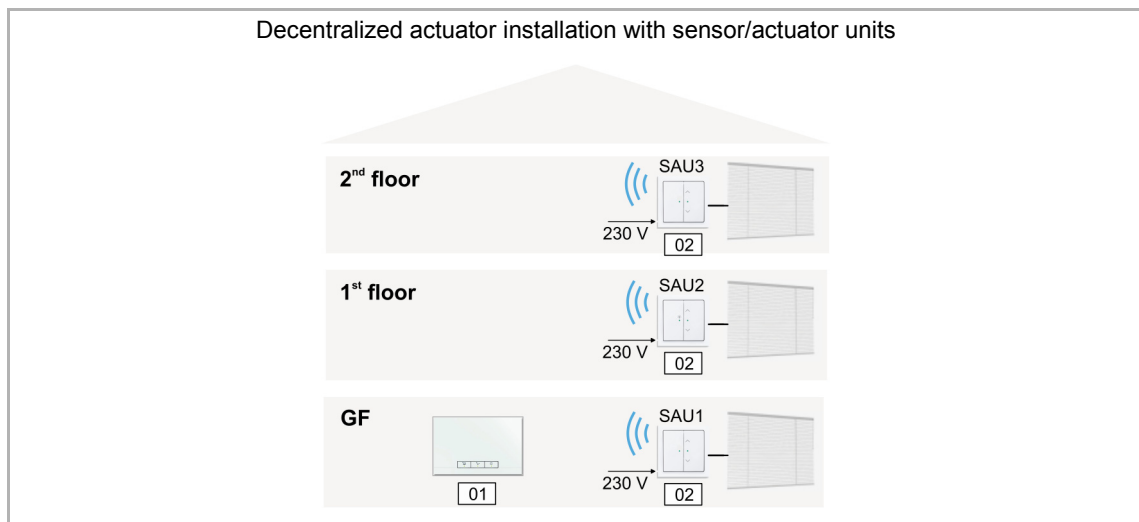

Fig. 6: Planning of the wireless actuators

01 – System Access Point

02 – Sensor/blind actuator unit

3.2.4 System features

Radio frequency	2.4 GHz
Radio protocol	free@home wireless
Encryption	AES-128
Transmission range in the building	Typically 15 - 20 m (can vary greatly depending on structural conditions)
Participants in the one system	Max. 64 wireless and 64 wired

Table 2: System features

- All free@home devices support the well-known free@home functions.
- Robust communication through "mesh network".
- Simple replacement of existing switches thanks to combined "sensor/actuator" devices.
- Immediate function without programming (devices are pre-configured).
- A system can include wireless and wired devices.
- Integration in the switch ranges future® linear, solo®, carat®, Busch-axcent®, Busch-balance® SI, Busch-dynasty®, pure stainless steel and basic55®.

Mesh network

All wireless network technologies have a physically limited transmission range. In a smart home, the participants of the network, such as the light switches and blind switches, are distributed over a large area but must still be able to reliably communicate with each other.

free@home uses the so-called mesh network topology to increase the maximum expansion of the network.

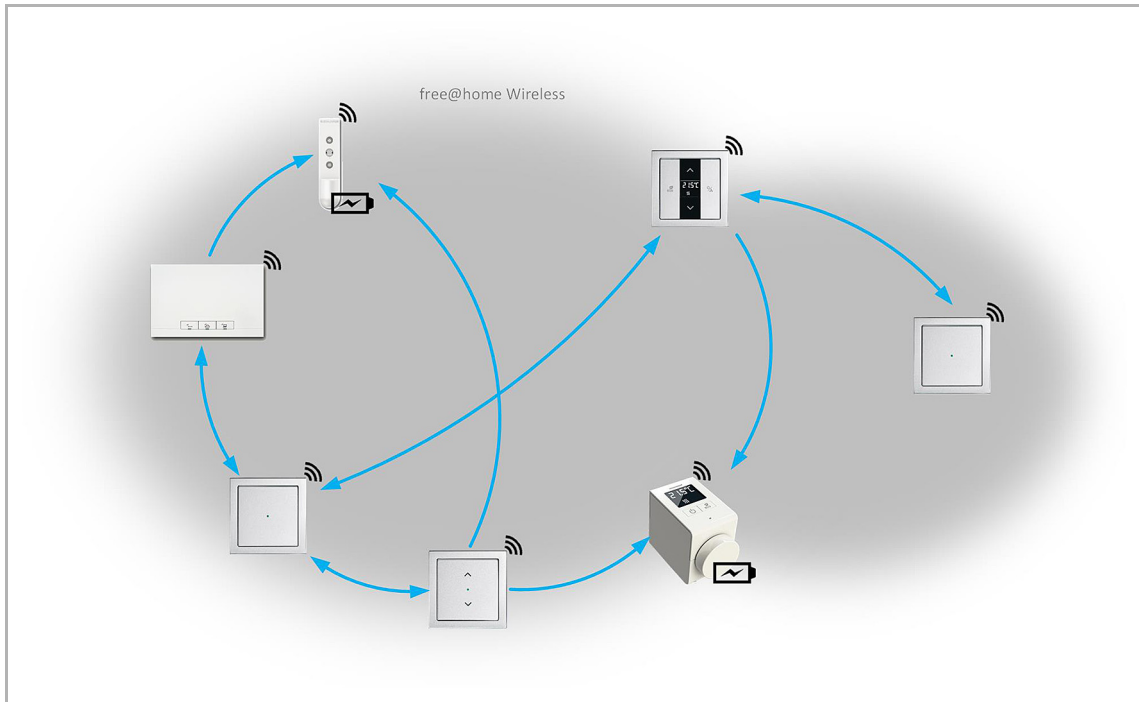

Fig. 7: free@home Mesh network

With the mesh-network topology each participant communicates with every other network participant. This happens either directly, if they are within range of each other, or indirectly via one or several communication nodes.

Other network types often use only central nodes through which the entire data traffic flows. Mesh networks do not have such a central transmission path. They find several ways to send data from one device to another.

The free@home mesh network uses the so-called routing process. During this process, the System Access Point automatically determines the most efficient way to send a message from one point in the network to the correct receiver via several nodes. This information is stored in so-called routing tables and distributed to all network participants.

The routing process is implemented on an ongoing basis so that the system can also react to subsequent changes, e.g. in the event of individual devices failing, new devices being added or constructional changes that impair the reception.

Transmission range

Take the mounting location of the free@home devices into consideration already during planning. In a free-field test a transmission range of 100 meters was reached. In buildings, however, this transmission range is not possible.

The local circumstances have large effect on the quality of reception or the transmission range of the devices, which dampens the signal more or less. That is why a general statement cannot be made about the transmission range, e.g. reinforced concrete ceilings dampen more than wooden ceilings; metal racks dampen more than wooden racks.

Observe the following general rules:

1. There should not be more than one storey ceiling between two devices.

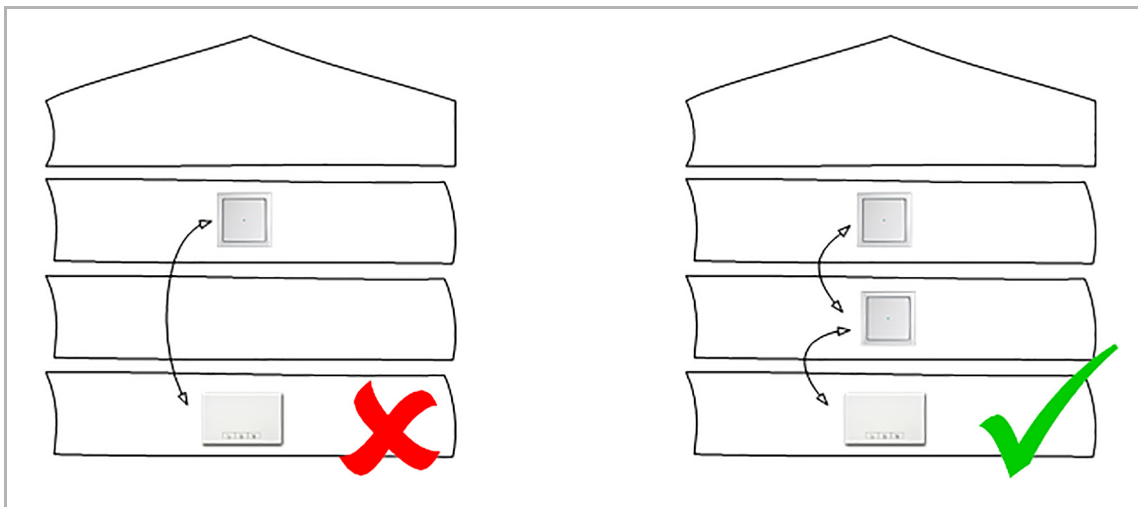

Fig. 8: Transmission range of storey barrier

2. There should not be more than one wall between two devices.

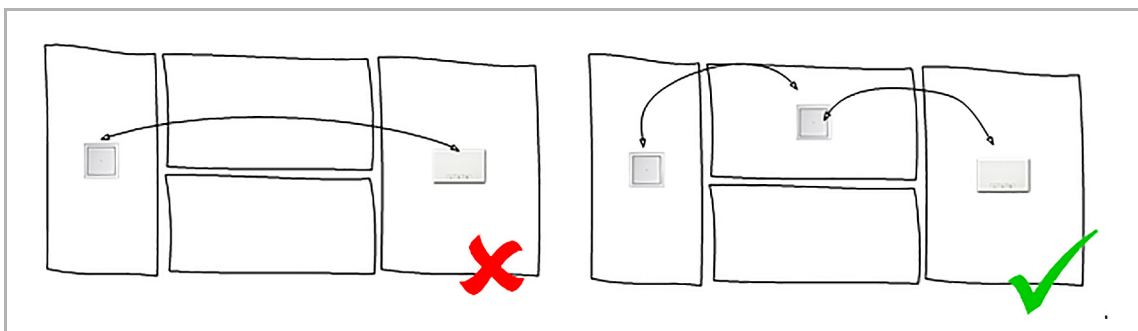

Fig. 9: Transmission range of wall barrier

3. The devices should not be installed directly next to large metal surfaces.

Interference of radio signal

The radio signal of the free@home devices should not be interfered with by other radio transmitters. Possible sources of interference are especially transmitters which transmit in a similar frequency range. This could include:

- WLAN routers (2.4 GHz)
- Microwaves
- Fluorescent lamps
- Cheap or defective electronic products

2.4 GHz WLAN devices represent the highest interference potential since they transmit in the same frequency range as free@home.

Effects of interference

The interference of the radio signal can have the following effect:

1. Delayed response
2. Disconnection to a participant

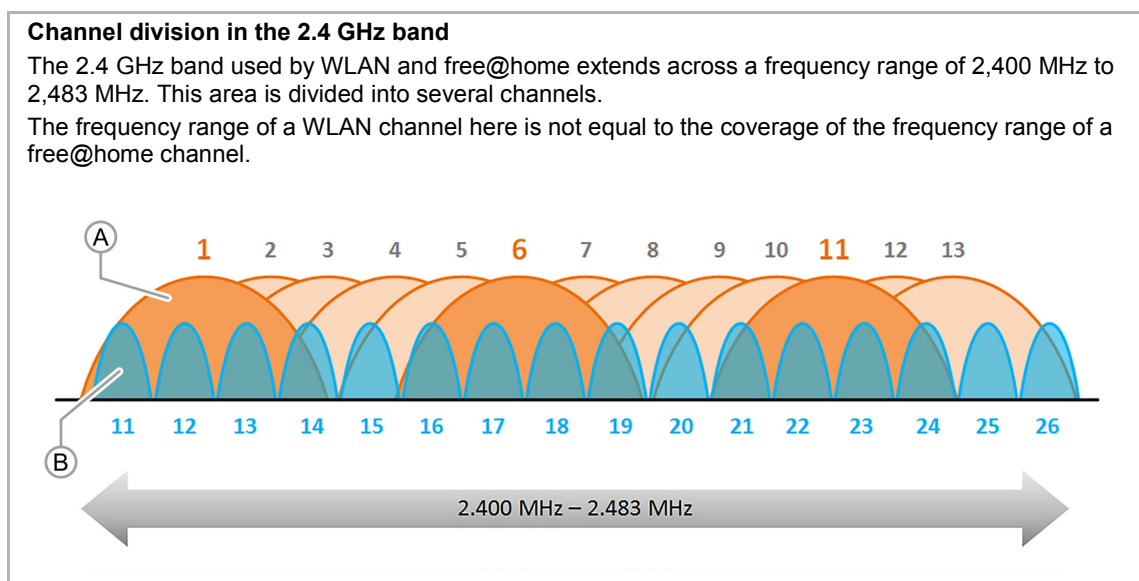

Fig. 10: Channel division in the 2.4 GHz band

[A] WLAN channels (1 - 13)

[B] free@home channels (11 - 26)

Avoiding interferences caused by 2.4 GHz WLAN

To prevent interference from the 2.4-GHz WLAN devices it would be best to remove the sources of interference, e.g. with the use of 5 GHz WLAN. Since this is generally not possible, the following should be observed:

- Use channels for the local WLAN and for the free@home network that lie in different frequency ranges, see "Channel division in the 2.4 GHz band". You can set the WLAN channel in the user interface of the router, or the free@home channel in the user interface of the System Access Point.

At the point of delivery of the System Access Point free@home channel 26 is set. In this case all WLAN channels from 1 to 11 can be used without any overlapping with the free@home frequency range.

- If there are adjacent WLAN networks on which you have no influence with regard to the selection of channels, position the free@home channel in a frequency range with the least load.

You can set a different free@home channel in the user interface of the System Access Point under "System settings" > „free@home-Wireless" > "Change channel".

After selecting the function, the automatic channel recommendation suggests a channel with the least interferences. The System Access Point then scans its surroundings for available WLANs, their channels and signal levels.

Used WLAN channels

In operating mode "WLAN Access Point" (during commissioning) the System Access Point uses WLAN channel 1. The channel cannot be changed.

The channel for the free@home communication is set on 26 as standard. This prevents the overlapping of the frequency ranges of the two radio protocols. The free@home channel in the "WLAN Access Point" should not be changed.

Automatic channel recommendation

During the boot-up process of the System Access Point all adjacent WLAN networks are scanned and analyzed for their frequency range and signal strength. If you confirm the "change channel" function, the automatic channel recommendation is output.



Fig. 11: Automatic channel recommendation

The WLAN networks that are available in the surroundings and the channels you are using can be determined with the aid of the free apps/programs, e.g.:

- **Wifi Analyzer** from farproc for Android (<http://wifianalyzer.mobi>)
- **WiFi Scanner** from AccessAgility for Mac OS and Windows (<http://wifiscanner.com>)

For example:

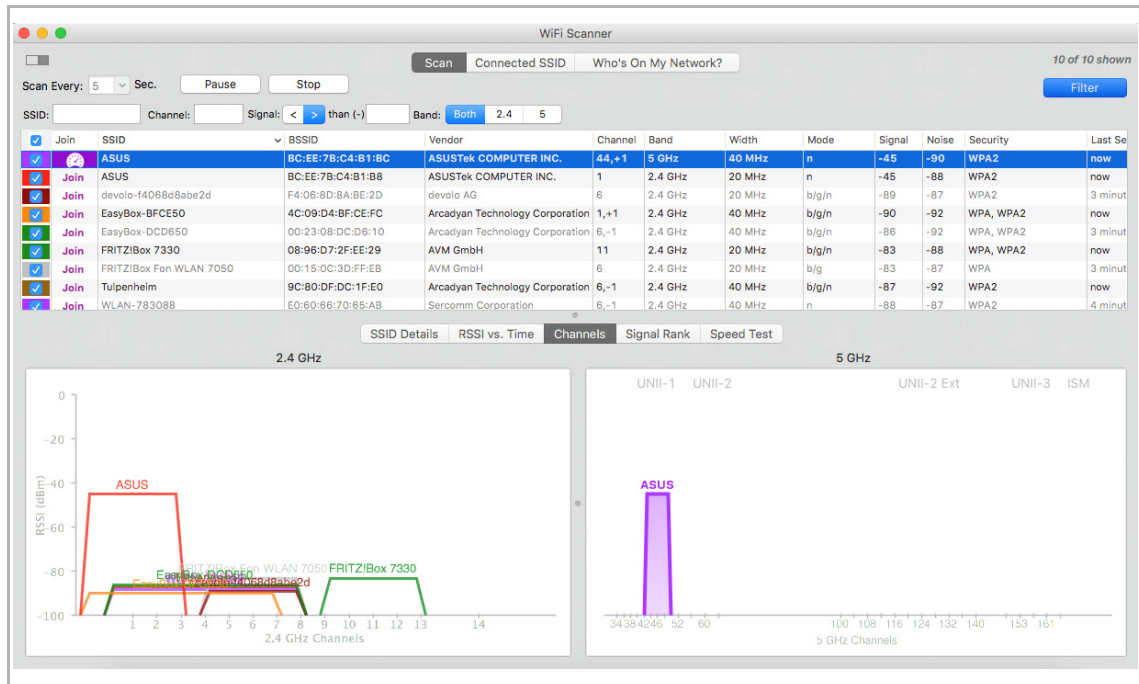

Fig. 12: Example of WiFi scanner

In Fig. 12 the local network "ASUS" occupies WLAN channel 1. All other frequencies of the 2.4-GHz frequency range are occupied by adjacent networks. However, these networks are damped to such an extent that no interferences of the free@home signal can be expected on channel 26.

3.3 Planning of the System Access Point

The System Access Point makes available its own WLAN during commissioning. This allows it to be comfortably programmed in mobile mode, even when no network infrastructure is available.

However, in the final state the System Access Point should be set up as participant within the available network infrastructure.

The System Access Point can be connected to the available network infrastructure of the apartment either via the installed Ethernet port or the installed WLAN antenna.

Connection via WLAN

If the System Access Point cannot be connected to the Internet router via cable, it can be logged into the existing WLAN network via WLAN as client.

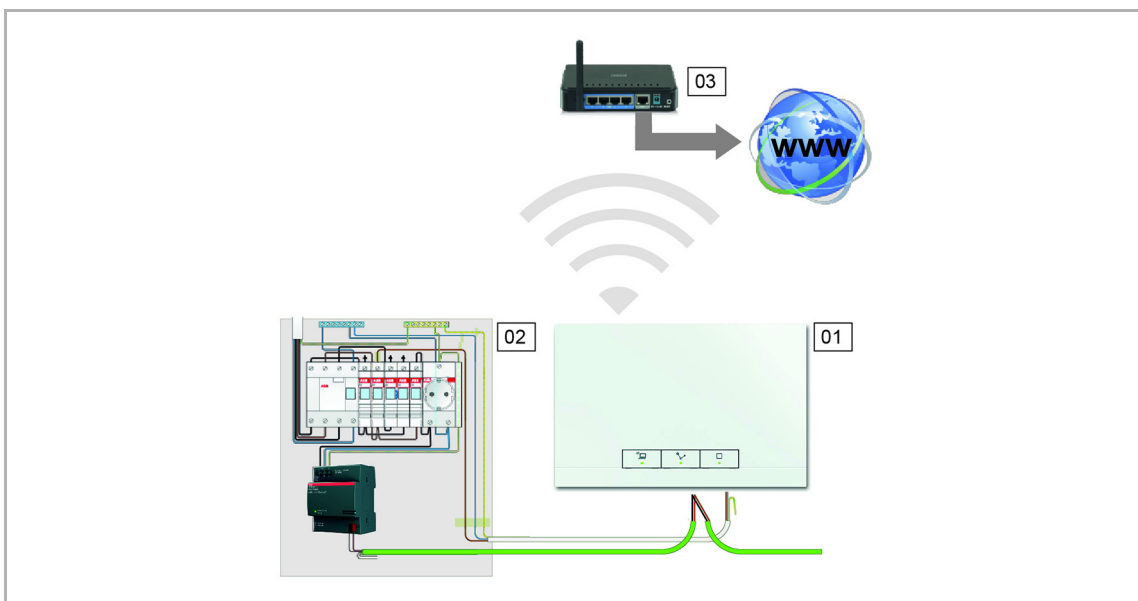

Fig. 13: Connection via WLAN

01 – System Access Point

02 – Distribution

03 – IP router

Connection via patch cable

If the System Access Point and Internet router are installed side by side, they can be connected via a patch cable.

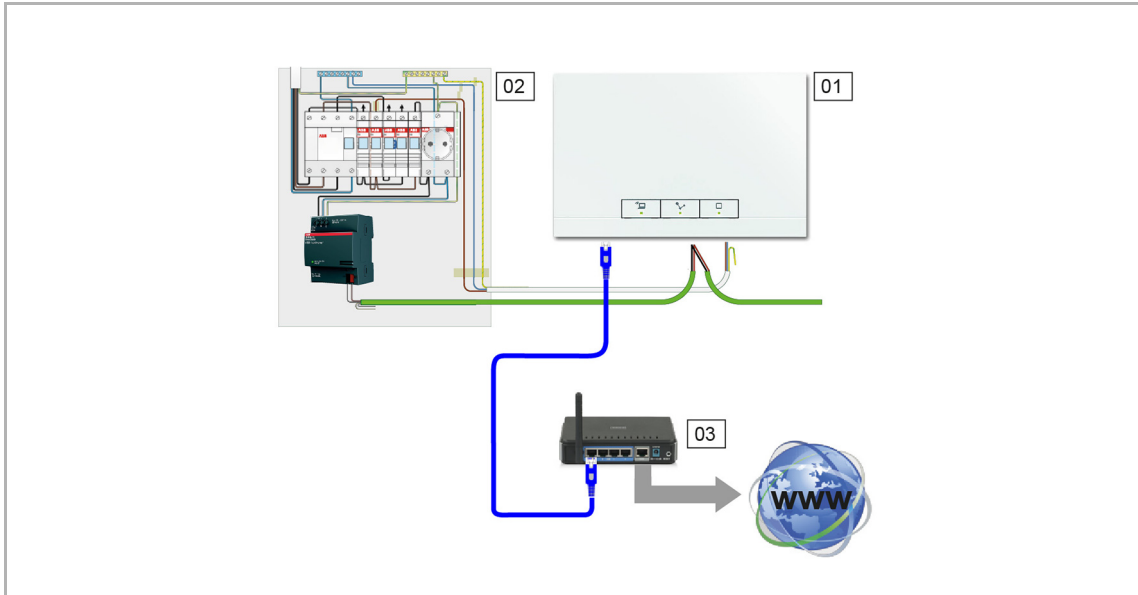

Fig. 14: Connection via patch cable

01 – System Access Point

02 – Distribution

03 – IP router

Connection via installation cable in case of structured cabling

If the System Access Point is to be connected via a CAT installation cable, it can be connected via the RJ-45 socket with an LSA adapter.



NOTE

The System Access Point switches over automatically to cable operation when a cable is plugged in.

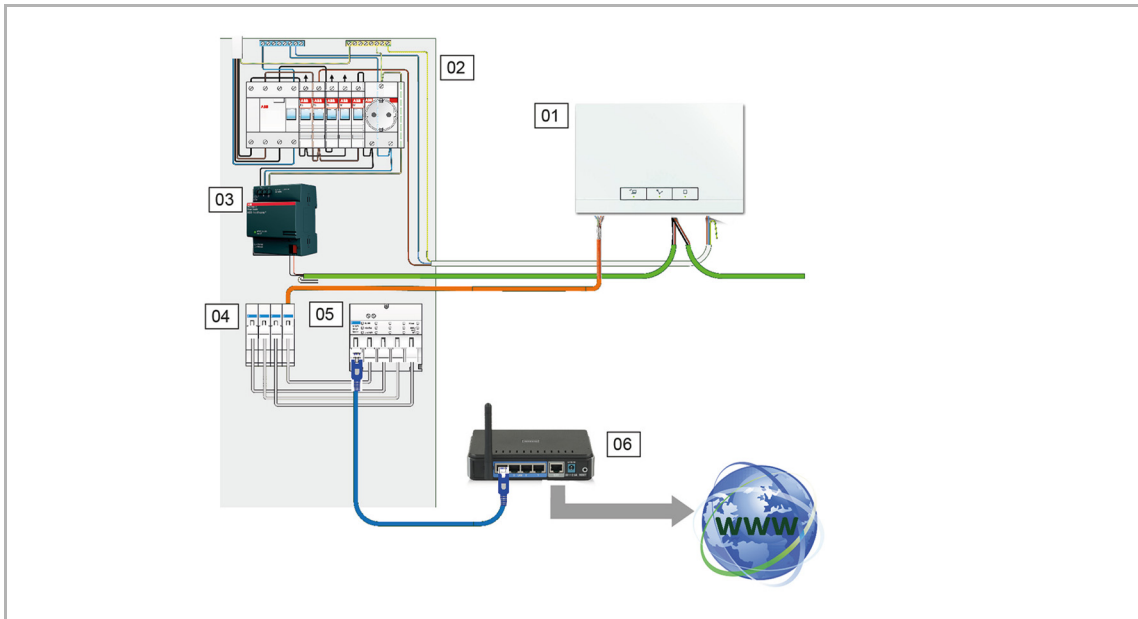

Fig. 15: Connection via installation cable in case of structured cabling

- 01 – System Access Point
- 02 – Distribution
- 03 – Power supply
- 04 – Ethernet patch terminals
- 05 – Switch
- 06 – IP router

3.4 Creating a plan for devices

Each free@home device has a clear, eight-digit serial number. It is affixed permanently to each device as well as on a removable identification label. The serial number serves as an aid for identifying the devices during commissioning.

To facilitate the input, a three-digit character code, which is generated from the specific serial number, is additionally available. Although it does not clearly identify the device, its accuracy, however, is sufficient to make it unique in the system.

To be able to identify the devices and channels more clearly during commissioning, document the three-digit character code of the devices, their function and location already during their installation.

- To do this, pull off the removable labels from the devices and document the associated functions on the enclosed master (see chapter 9.2 "Device plan master" on page 117).

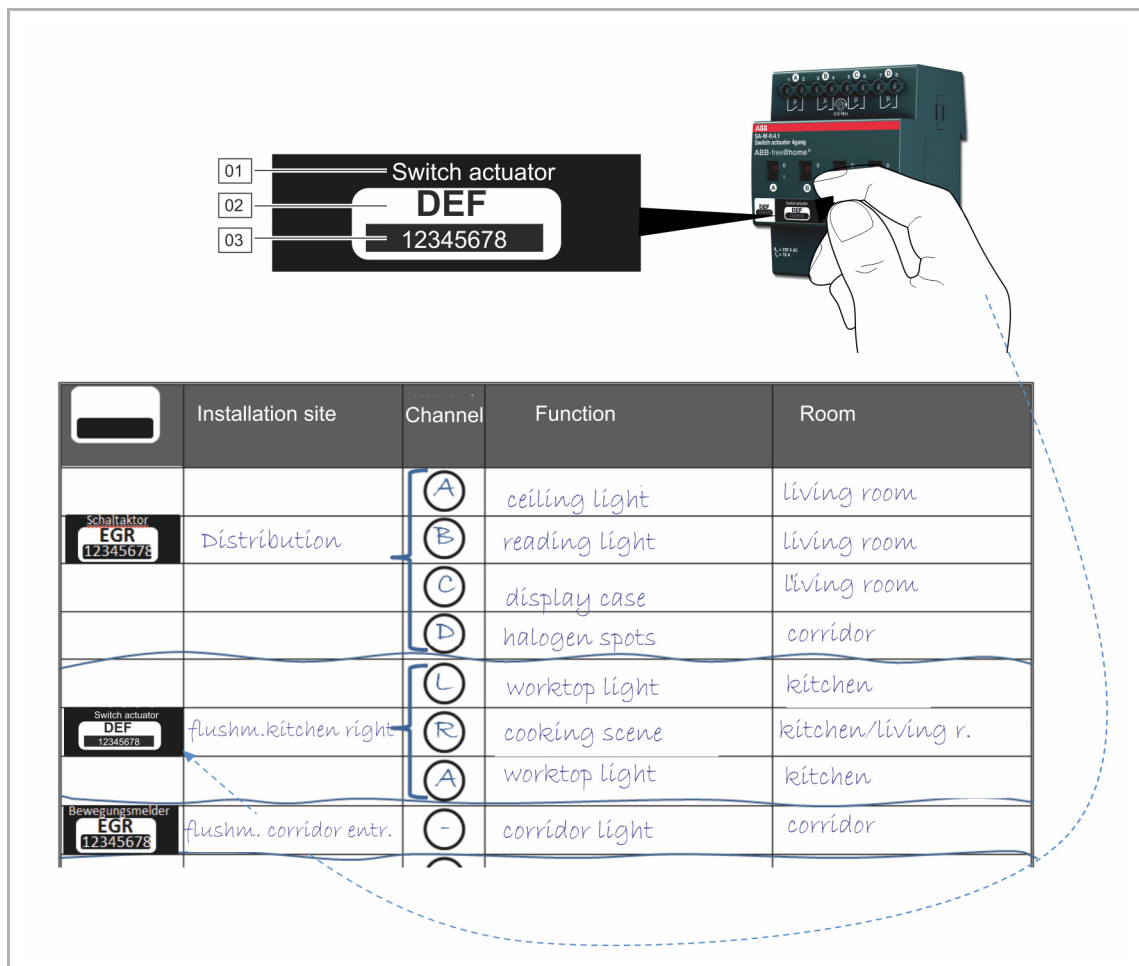

Fig. 16: Plan of devices

- 01 – Description of device
- 02 – Character code
- 03 – Serial number

4 Commissioning

4.1 Prerequisites

Commissioning is always carried out via the System Access Point.

- A smartphone, tablet or PC is required for commissioning.
- No additional software is required.

The use of the free@home app is recommended for commissioning via smartphone or tablet, it can be downloaded free of charge from the App Store (for iOS) or from the Google Play Store (for Android).

4.2 Establishing the connection to user interface of the System Access Point

Use one of the following options to open the user interface of the System Access Point.

Option A: Establishing the connection with smartphone or tablet

1. Install the free free@home app for Android or iOS.
2. Energize the System Access Point. Ensure that the access point mode has been activated (left button lights up). If not, press the access point button to activate it.
3. Connect the terminal device with the WLAN of the System Access Point (SSID: SysAPXXXX).
Enter the password (see text on the interior side of the power adapter in the System Access Point; open the cover for access).

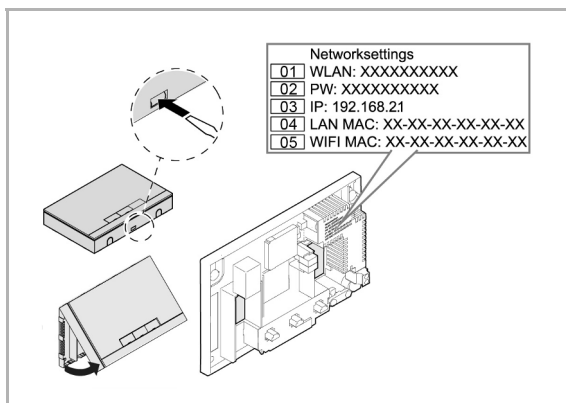

Fig. 17: Text on the interior side of the System Access Point

- 01 – WLAN password (SSID)
- 02 – Password
- 03 – IP address
- 04 – LAN MAC address
- 05 – WIFI MAC address

4. Start the app.
5. The app establishes a connection to the System Access Point automatically.



Fig. 18: Connection with smartphone or tablet

Option B: Establishing the connection with the PC via WLAN

1. Energize the System Access Point. Ensure that the access point mode has been activated (left button lights up). If not, press the access point button to activate it.
2. Connect the PC with the WLAN of the System Access Point (SSID: SysAPXXXX). Enter the password (see text on the interior side of the power adapter in the System Access Point; open the cover for access, see Fig. 17).
3. Start your Internet browser. Enter the IP address "192.168.2.1" in the address line of your browser and confirm it.
4. The connection to the System Access Point has been established.

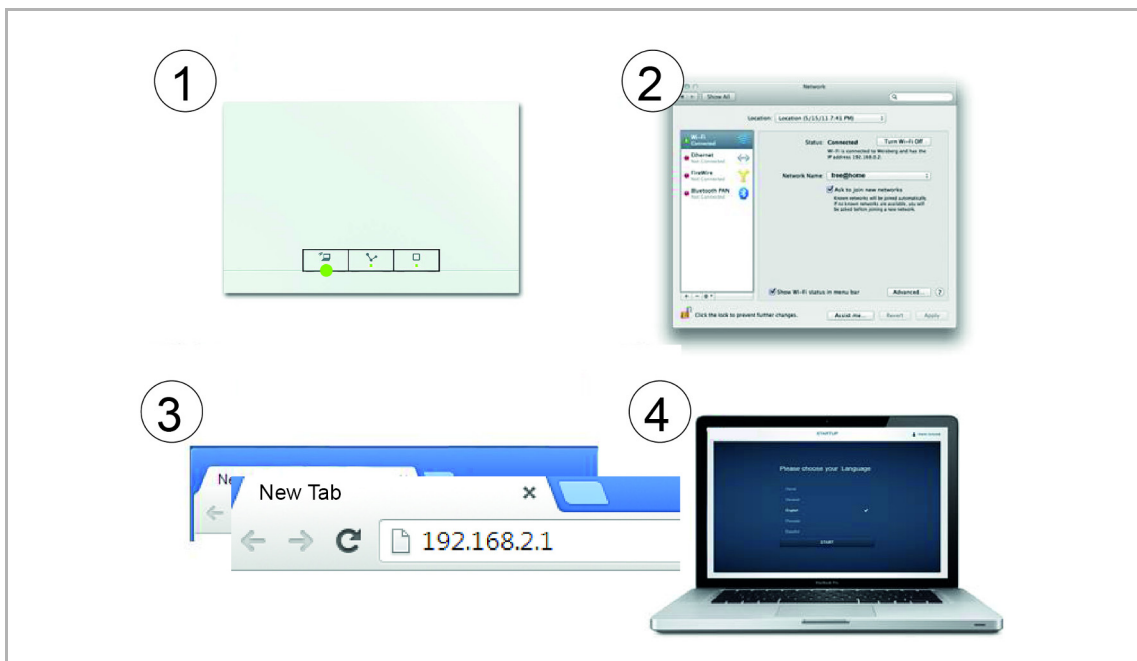

Fig. 19: Connection with PC via WLAN

Option C: Establishing the connection with the PC via patch cable and router

1. Connect the System Access Point and the PC with the router.
Energize the System Access Point. Ensure that the access point mode has not been activated. If it is activated, press the Access Point button to deactivate it.



NOTE

The System Access Point now operates as "DHCP Client", this means that it can only be reached under the IP address that is assigned to it automatically by the router.

2. Call up the user interface of the System Access Point. For this there are two options:
 - [A] Open the Windows Explorer of your PC. The System Access Point is displayed as device under "Network". Double click on the device to open the user interface (prerequisite: the computer must support UPnP).
 - [B] Enter the IP address that is automatically assigned by the router in the address line of your browser. You find the assigned IP in the user interface of your router. Example, FRITZ!Box: under "Home network > Network". Set the view on "Extended" to fade in the IP addresses.
3. The connection to the System Access Point has been established.

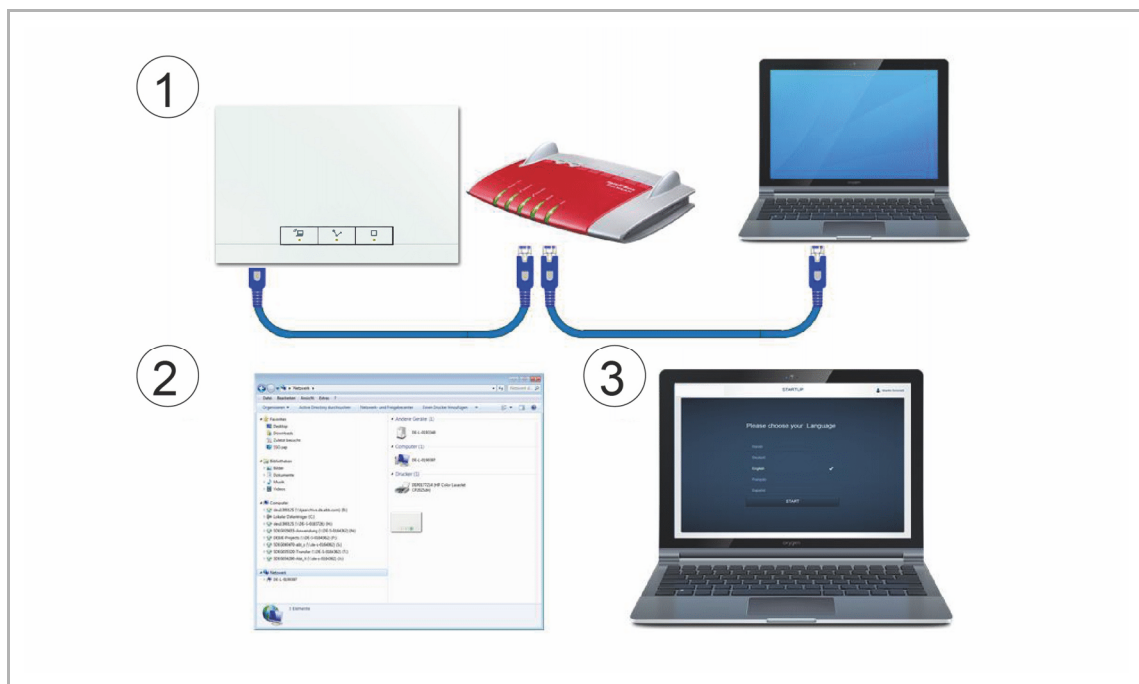

Fig. 20: Connection via patch cable and router



NOTE

Description of status LEDs, see chapter 5.5.4 "Control and display elements" on page 88.

Option D: Establishing the connection with the PC via patch cable and without router

(Available from System Access Point Firmware Version 2.0)

1. Connect the System Access Point and the PC with a patch cable (no special crossover cable is required)

Energize the System Access Point. Ensure that the access point mode has not been activated. If it is activated, press the Access Point button to deactivate it.



NOTE

The System Access Point now operates as "DHCP Client", this means that it can only be reached under the IP address that is assigned to it automatically by the PC.

2. Call up the user interface of the System Access Point.

Open the Windows Explorer of your PC. The System Access Point is displayed as device under "Network". Double click on the device to open the user interface (prerequisite: the computer must support UPnP).

3. The connection to the System Access Point has been established.

4.3 Basic settings



NOTE

Detailed descriptions are available in the online Help in each of the individual pages under button:



During initial commissioning you will be asked to supply the following basic data:

Language

Selects the language of the display text. The following languages are available:

English	French	Portuguese	Turkish
Danish	Italian	Russian	Czech
English	Norwegian	Swedish	
Spanish	Dutch	Chinese	
Finnish	Polish	Greek	

Table 3: Languages



Fig. 21: Basic settings

Site

Basis for the astro function.

Time/Date

Sets the system time (the time will be synchronized automatically when the connection to the Internet is established).

User name / Password

Ensures protection of the settings against faulty configuration (additional users can be added later).

**NOTE**

The password must consist of at least 4 characters.

Name of installation

Display name of device within the IP network.

The data are saved on the System Access Point. The entry of the data can be skipped, which, however, can lead to the restriction of functions.

However, the data can also be entered at a later point in time.

4.4 User rights

The system differentiates between three types of users with different access rights:

User 'Fitter'

- Has all access rights (Master reset, creation of data protection).

User 'Configuration'

- Cannot make changes critical to the system (changing settings related to the bundling of channels for dimmers, re-configuration of binary inputs).

User 'Operation'

- Cannot make changes to the system, but only operate the devices.

4.5 Setup of the main menu

The main menu is the starting base for all the steps to follow.

Located in the central area are the menu items that are to be processed step by step (from left to right) for the configuration.

Since the steps follow each other consecutively, they remain deactivated until the preceding step has been executed.

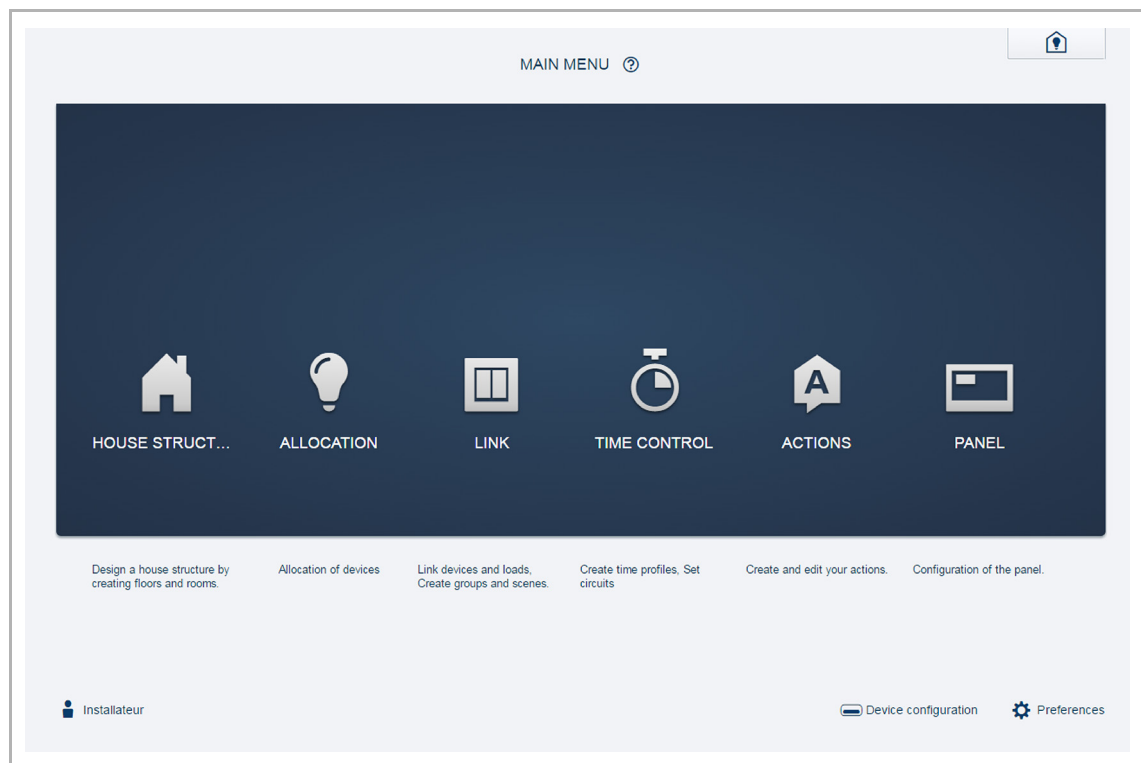

Fig. 22: Setup of the main menu

4.6 Setup of the working area

The working area of menu items "House structure", "Allocation" and "Linking" is divided into two areas: the floor plan (working area) on the left side and the list view on the right side.

- Each area can be enlarged or reduced via the title bar.
- All actions can be carried out both in the floor plan and in the list view.
- If a change is made in the floor plan, this change is also made in the list view and in reverse.
- Both areas represent different views of the same configuration.
- While the floor plan represents the graphical view and allows operation via drag and drop, the list view offers a clear tabular view.

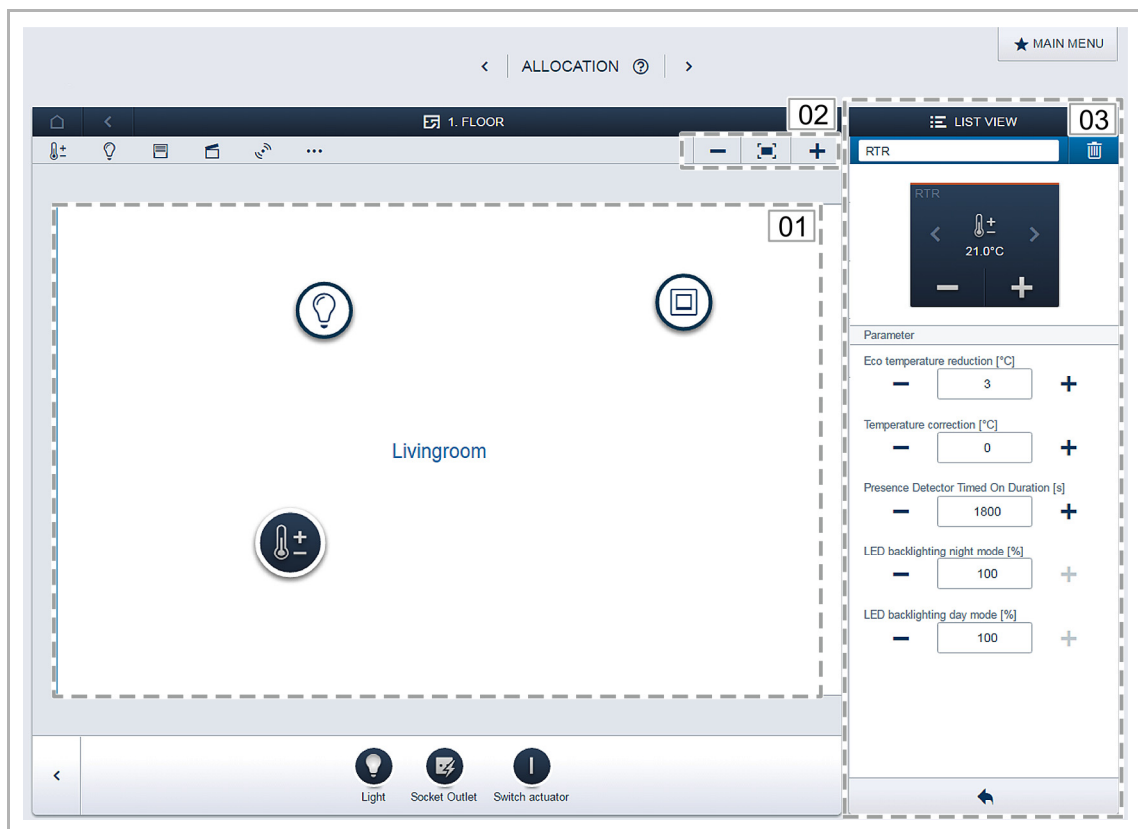

Fig. 23: Setup of the working area

01 - Floor plan

02 - Enlarge/Reduce

03 - List view

4.7 Creating the house structure

The first step of the configuration is the creation of the house structure. Here a digital image of the apartment or the house with all its floors and rooms is created.

This information is used during the next step to allocate the devices available in the house to a function and to their mounting position. After commissioning has been completed the created floor plan is also used for the visualization of the installation and as orientation for the switchable loads.

To allocate devices in the outdoor area, e.g. lights on the terrace or in the garden, create a "Terrace" or "Garden" room.

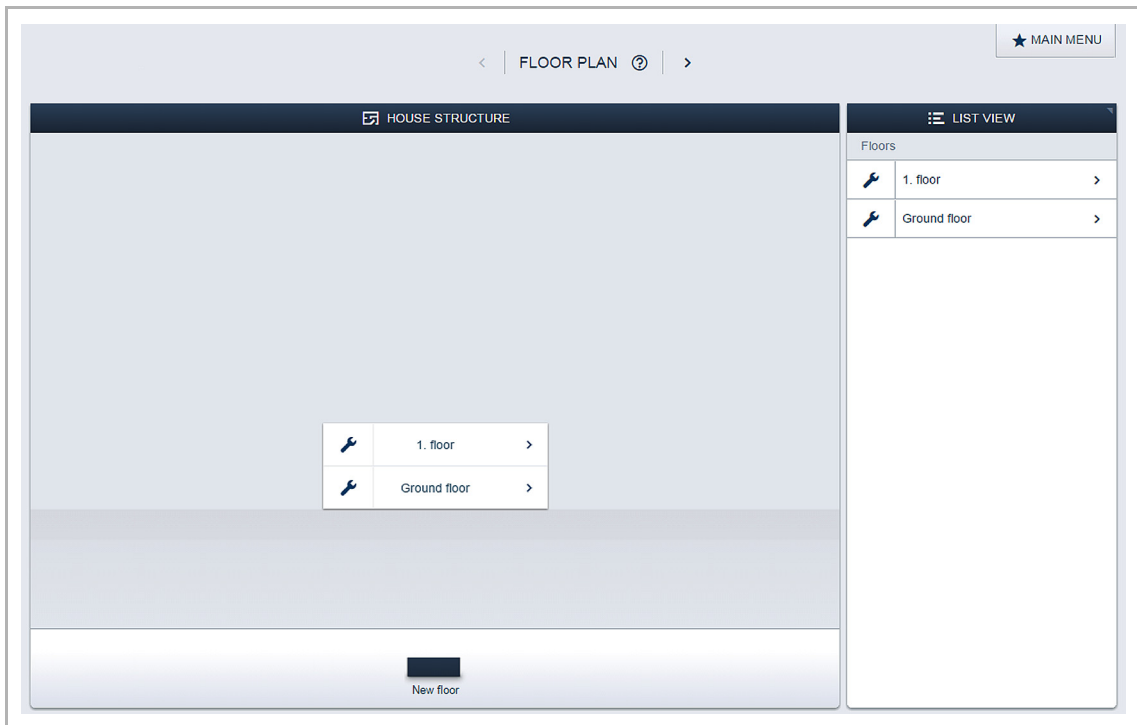

Fig. 24: Creating the house structure - View of all floors

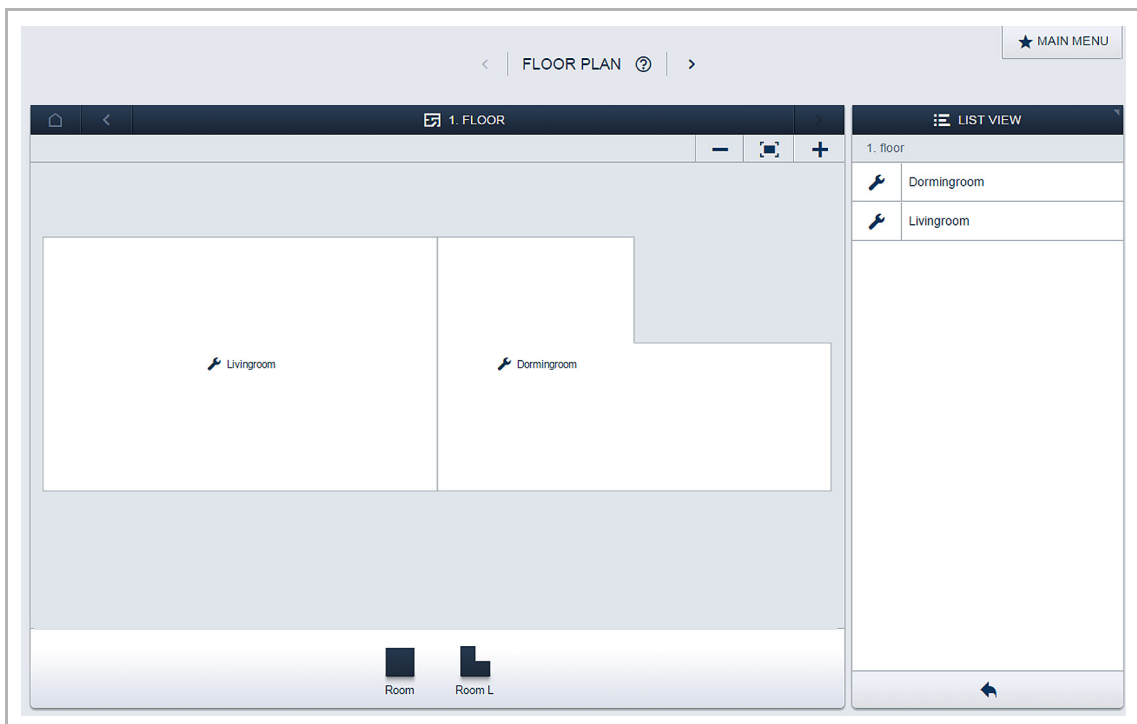

Fig. 25: Creating the house structure - View of one floor

4.8 Allocating devices to rooms

In the next step the devices connected to the system must be identified. For this they are allocated to a room according to their function and are given a descriptive name.

A table with all available applications is located in Chapter 6 "Device Functions" on page 91. The application that is actually available depends on the devices connected to the system.

In the "Add device" bar only the devices/functions that are connected with the system are displayed. They remain in the bar until they are shifted onto the floor plan. This means that the list keeps getting shorter as the devices are being positioned.

- In the "Add devices" bar select the desired application and pull it via drag and drop onto the floor plan, see Fig. 26.
 - A pop-up window opens which lists all the devices that are connected to the bus and suitable for the selected application (e.g. all blind actuators, if the blind application has been selected, see Fig. 27).

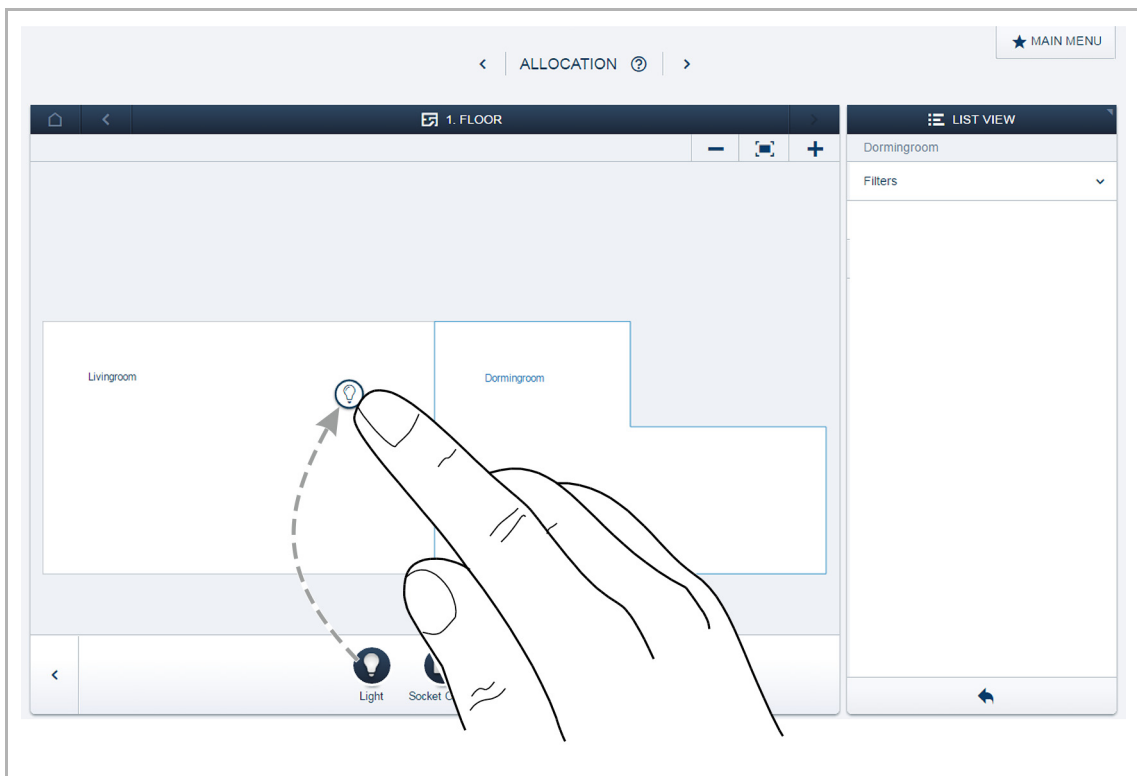

Fig. 26: Dragging the application from the add bar



Fig. 27: Pop-up window with the suitable devices

4.8.1 Identification

If after positioning on the floor plan there are several possible devices in the pop-up window for selection, the device which switches the desired function must now be selected.

Identification via serial number

- Compare the three-digit character code and the serial number of the identification label on your device plan, or on the device with the numbers in the list, and in this way identify the device you are searching for and, if necessary, also the channel.

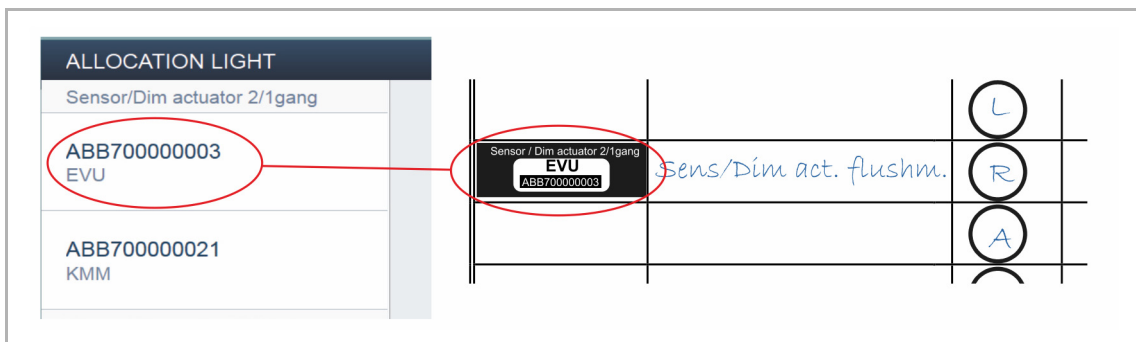

Fig. 28: Identification via serial number

Identification via local operation

Actuate the device that is to be linked with the selected application.

- Actuator: Press the "Ident" button on the device.
- Sensor: Press the rocker.
- Movement detector: Cover the lens with the hand.

The associated device is selected automatically. In case an actuator has several channels, you need to select the correct channel.

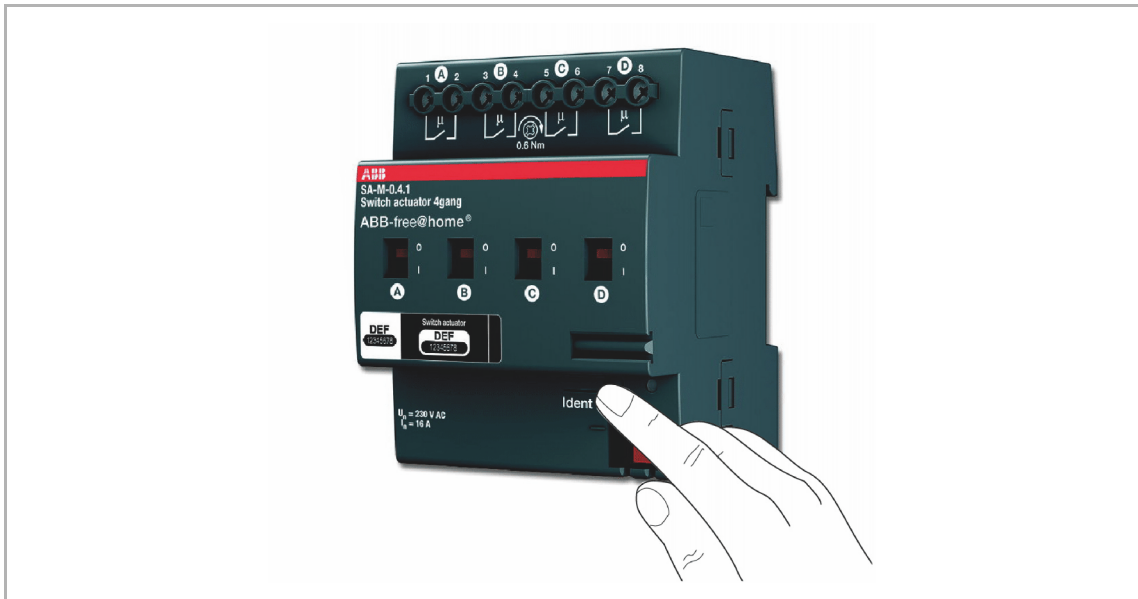

Fig. 29: Identification via local operation

Identification via switching (only suitable for actuators)

1. Select a device and a channel from the list.
2. Press the button in the detailed view of the device.
 - The connected load is switched.
3. Repeat steps 1 and 2 until you have located the searched for device.

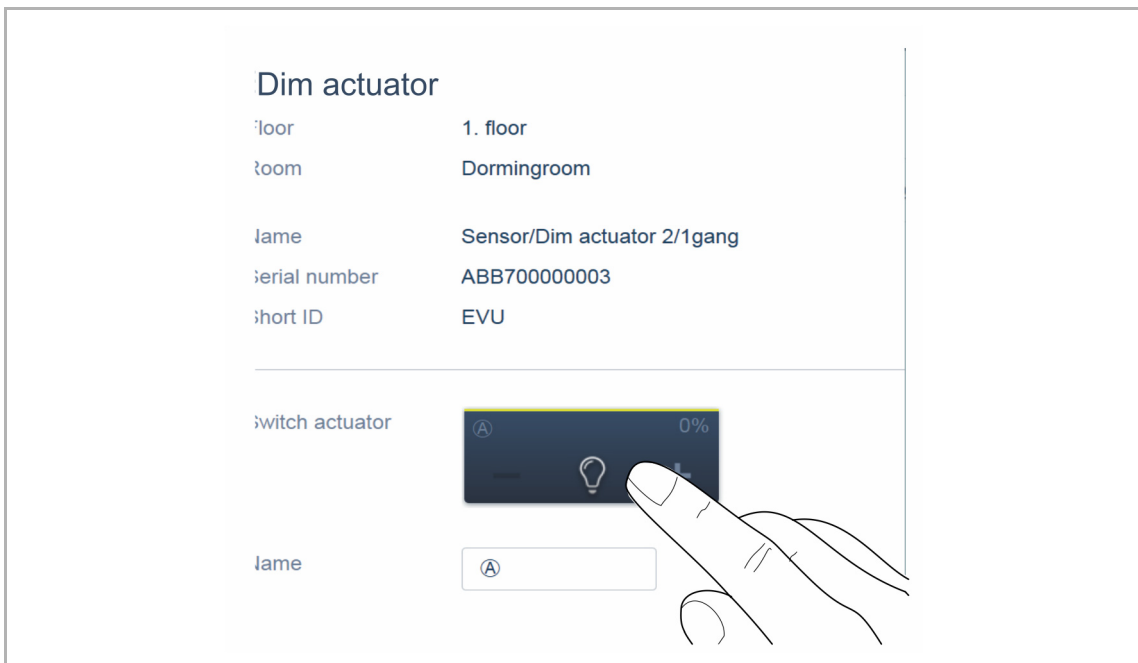

Fig. 30: Identification via switching

4.8.2 Specifying a name

- When the device has been found, enter a name that is easy to understand and under which the application is to be displayed later (e.g. "Ceiling light").
- Press the tick at the bottom right to take over the entries.

The screenshot displays a commissioning interface with a list of detected devices on the left and a naming field on the right. The devices listed are:

- ABB700000006 SFH
- ABB700000016 WDG
- Movement detector/actuator 1g...

The 'Name' field is currently set to 'Ceiling light'. At the top right, there is a dark blue button with a lightbulb icon and a plus sign. At the bottom, there are two buttons: a back arrow on the left and a checkmark on the right.

Fig. 31: Specifying a name

4.9 Linking sensors and actuators

The sensors and actuators created in step "Allocation" can now be linked to implement simple On/Off circuits, two-way circuits, scenes, etc.

1. First click/tap on the desired sensor [1] which is to operate the actuator and then on the actuator [2].
2. Press the tick at the bottom right to take over the entries.
 - A blue connecting line indicates the link between the two devices.

The configuration is transmitted automatically to the devices. The transmission can, depending on the number of affected devices, take a number of seconds. During the transmission a progress bar is displayed around the devices affected.

After the transmission has been completed the sensor can be operated directly locally.

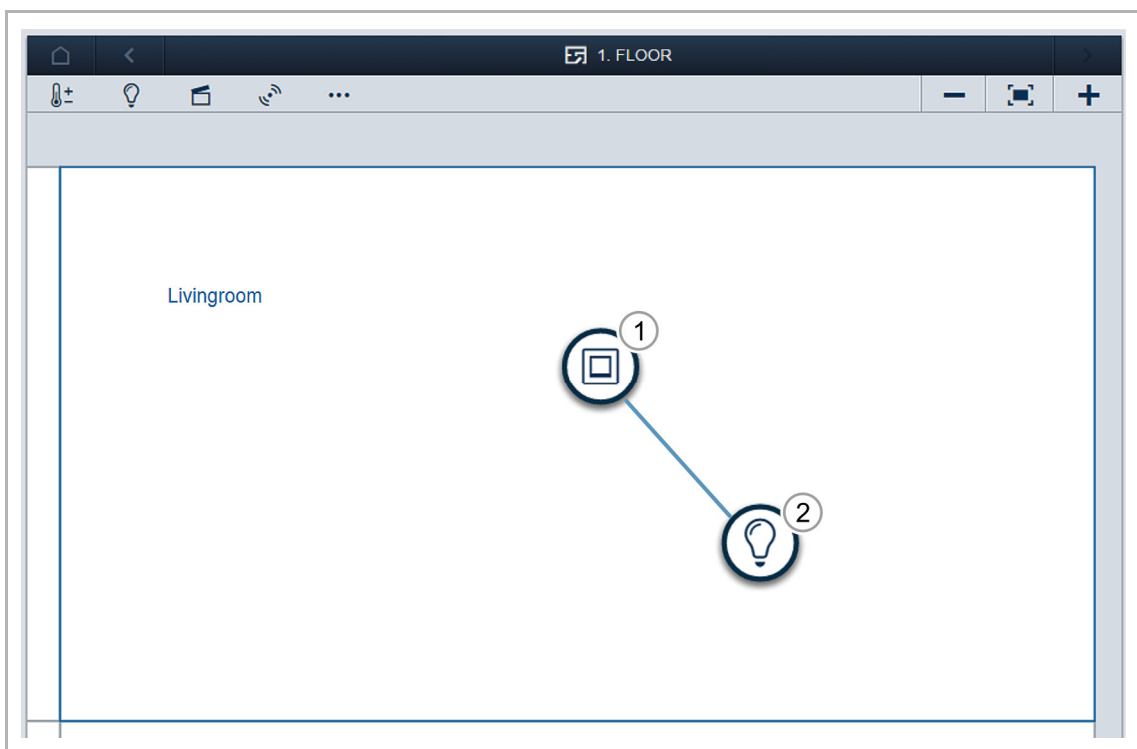

Fig. 32: "Allocation" window

4.9.1 Switching options

Two-way circuit [01]

An actuator is connected with one or several sensors.

Group circuit [02]

Several actuators of the same type (e.g. all the lights in a corridor, all roller blinds of a room) are combined in a group. The group acts like a single actuator and can be connected with sensors or integrated into scenes (At "ON" all actuators of the group switch on. At "OFF" all actuators of the group switch off).

Scene [03]

A scene creates a state that can be defined by the user. This, for example, allows the user to create a "TV" scene that dims the living room light, switches off the lights in the corridor and dips the blinds. Scenes cannot be switched on or off. When a scene is called up, always the same, predefined state is established.

The states of the participants in a scene can be defined when the scene is created.

To switch a local scene, it can be linked with a sensor.

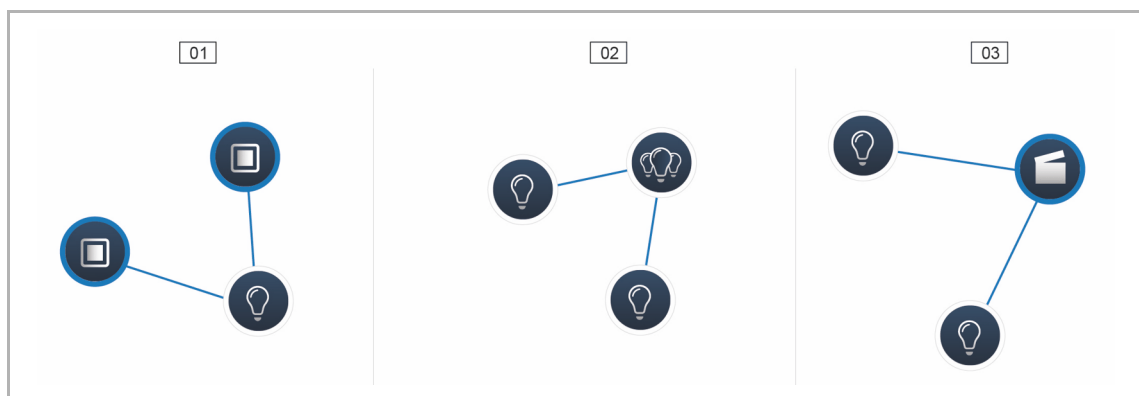

Fig. 33: Switching options

01 – Two-way circuit

02 – Group circuit

03 – Scene

4.10 Time control

All programmed devices and scenes of the system can be switched automated via the timer (time profiles).

4.10.1 Time profiles

A time profile defines a collection of switching times. Several time profiles can be created and switched active / inactive independent of each other (tick = time profile active, the saved switching actions are executed).

To obtain better visual clarity, for example, separate profiles for controlling blinds and lighting can be created. Or a special holiday profile can be created, which you only activate during your absence.

All time profiles are displayed in the profile view. When selecting a profile, all switching times for devices and scenes stored in this profile are indicated on a timeline in an overview display.

Additional profiles can be created and existing ones renamed or deleted via the spanner icon [04].

- First select the profile you wish to edit. Then click/tap on the spanner.

Contents from the profiles that have already been created can be taken over into the currently active profile via the arrow icon in the editing mode.

The base profile has already been created in the factory state.

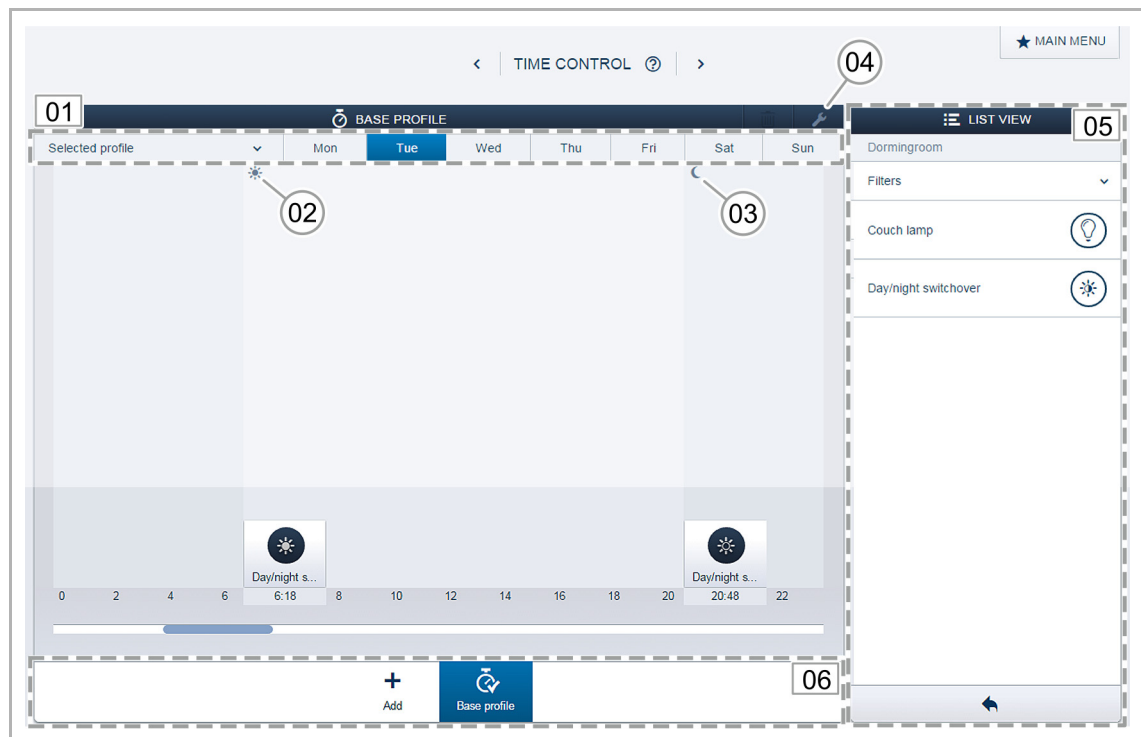

Fig. 34: Time profiles

01 – Selected profile - timeline

02 – Sunrise

03 – Sunset

04 – Edit profile

05 – List view

06 – Overview of profiles

Base profile

The base profile can be freely edited. It already contains the object "Day/night switchover" in astro mode. The day/night switchover serves the control elements and the dimmers as switchover time between bright and dark for the status LED, or for the switch-on brightness. The day/night switchover is settable in the parameters of the control element, the dimmer and the room temperature controller).

Examples of application:

- The light in the corridor is not to switch on with 100% brightness after 11 p.m., but with the reduced brightness of 40%.
- The light for orientation of the sensors in the bedroom is to be switched off after 11 p.m.

Presence profile

The presence profile is a special time profile with which presence simulation can be implemented.

The timeline of the presence simulation is filled with the desired switching actions, the same as a normal time profile. However, no switching time needs to be defined. Instead, the switching times are filled automatically with historical data of what actually took place.

The presence simulation therefore represents an image of customary use.

All the events of the last seven days are stored in the historical data. What is not stored are events that were switched on and off in quick succession.

The presence simulation can be edited, activated and deactivated the same as all other time profiles. This means that additional switching events can be added or certain events deleted.

4.10.2 Timeline

The timeline displays all the switching times of a selected weekday. Switching actions that take place at the same time are displayed stacked.

The sun and moon icons indicate the time for sunrise and sundown.

The selection of a certain switching event changes the view to a detailed view (Fig. 35). Here the switching time can be adjusted. Also the weekdays can be defined at which the event is to be repeated. Or the circuit can be activated via the astro function.

Switching times can be linked with the times for sunrise and sunset via the astro function.

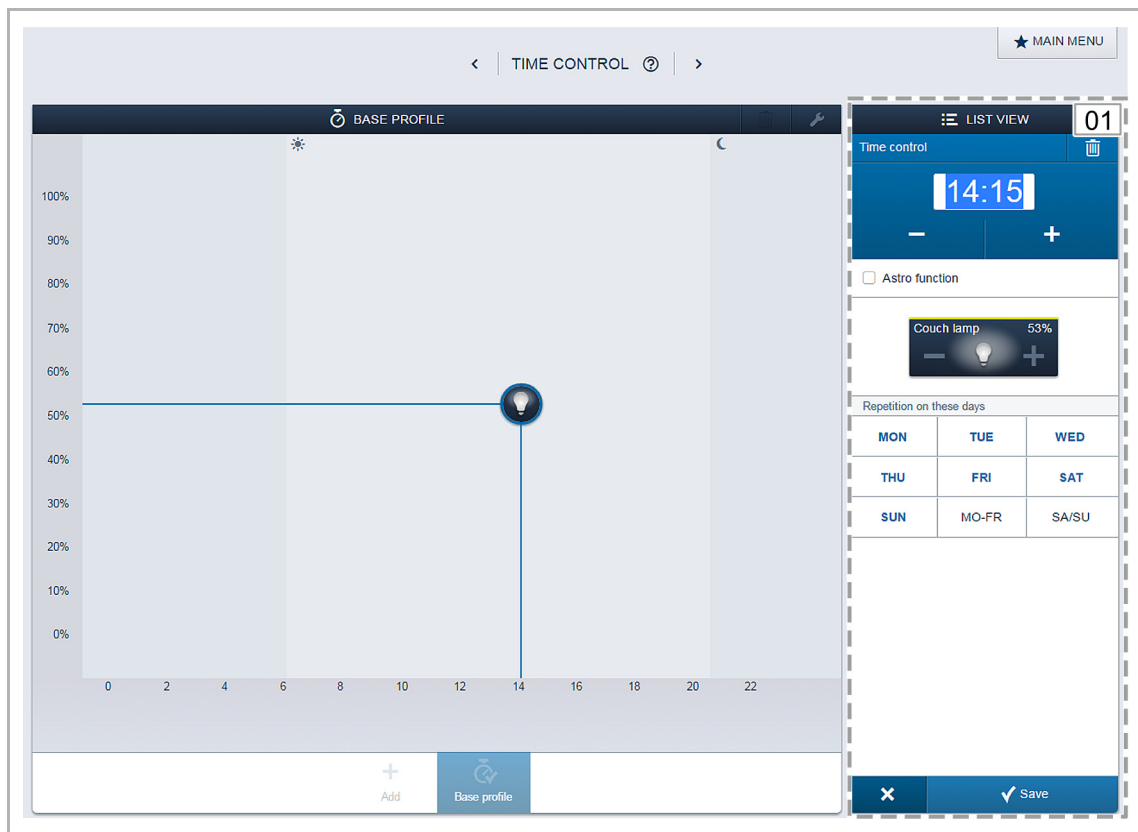

Fig. 35: Timeline - Detailed view

01 – Time setting

4.10.3 List view

All devices and scenes that have been programmed can be selected via the list view, sorted according to mounting position.

- To define the switching times for a device or a scene, pull it onto the timeline via drag and drop (see Fig. 34).

4.11 Actions

In menu "Actions" you can configure simple "When-then" relationships.

This allows rules to be created, such as implementing an automatic shading function:

"Move the blind to 50% when the room temperature exceeds 25°C".

Or you can create an automatic notification, for example, for movement detectors in the house:

"Send an e-mail when the movement detector has triggered".

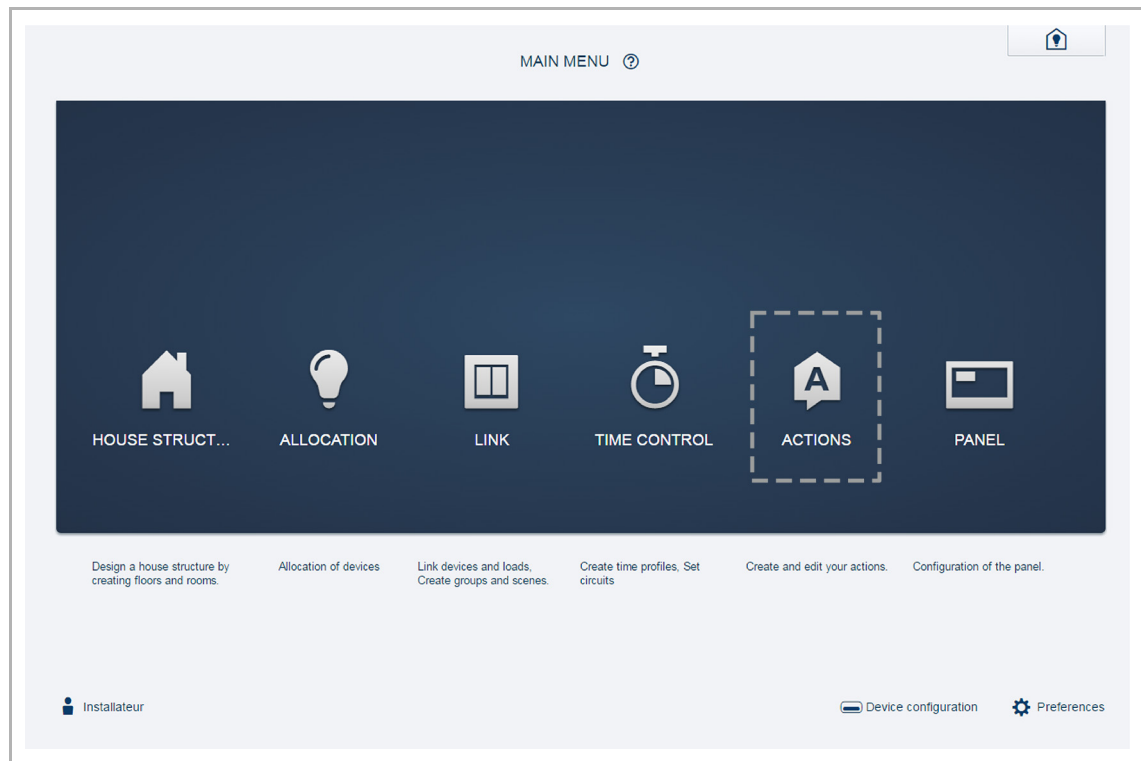

Fig. 36: Actions

4.11.1 Parts of an action

Precondition	Event	Action	Notification
<p>A precondition defines when an action is to be active.</p> <p>Application examples:</p> <ul style="list-style-type: none"> ▪ A shading function is to be activated only during the summer months. ▪ An automatic notification is to be sent only when no one is in the house. <p>Preconditions are optional, which means that without a precondition the action becomes active directly.</p>	<p>An event defines the signal that is to start an action.</p> <p>One or several free@home sensors can be defined as signal generator.</p> <p>As soon as a sensor has been triggered (e.g. a push-button is pressed, a binary input contact is closed, a movement detector detects movement), the event is triggered and the action is started.</p> <p>At least one event must be configured for each action.</p>	<p>An action defines the actions that are to be carried out as soon as an event has occurred.</p> <p>Any number of free@home actuators can be defined.</p>	<p>A notification is sent as soon as an event has occurred.</p> <p>A notification can be sent as e-mail or as push message (precondition is the registration at myABB Living Space®).</p> <p>The text of the message can be specified individually by the user.</p> <p>A message can be sent to several different receivers.</p>
<p>Several preconditions can be defined for each action.</p> <p>All preconditions must have been met before an action becomes "active".</p>	<p>If several events are configured, the action is carried out as soon as one of the configured sensors triggers (logic OR connection).</p>	<p>One or several actuators can be configured for each action.</p> <p>All defined actuators switch if an event is triggered.</p>	<p>–</p>

4.11.2 Time diagram

The time-related dependence between sensors and actuators of an action can be influenced via parameters. The relevant parameters and the influence they have on the switching behaviour is illustrated in the following graph:

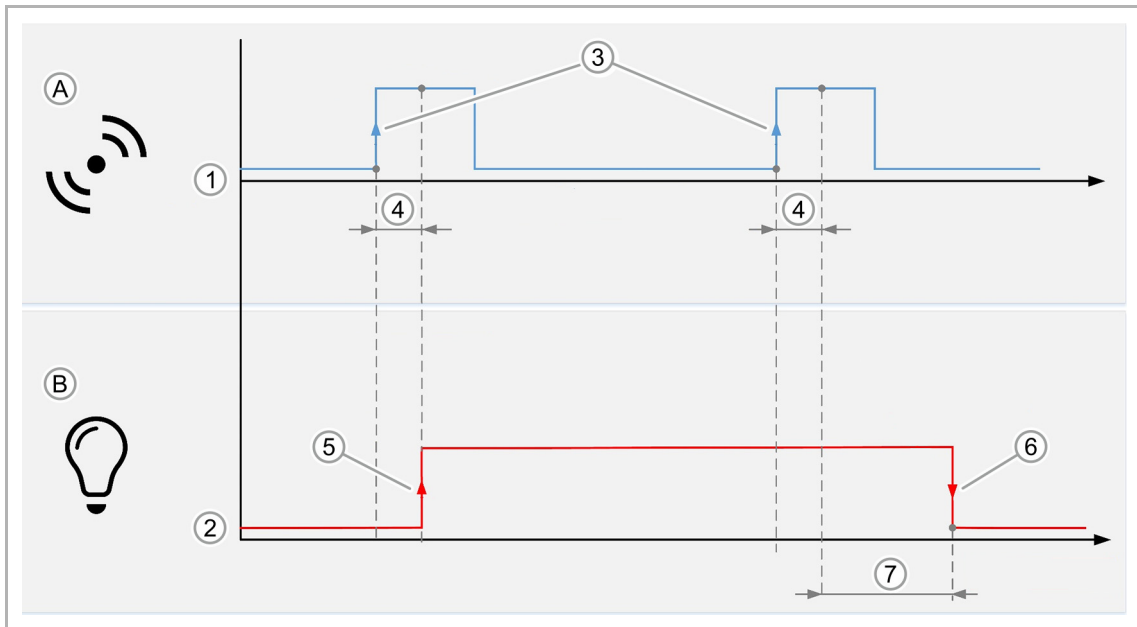
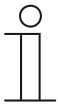

Fig. 37: Time diagram – Event/action

- A – Event
- B – Action
- 1 – Sensor- signal level
- 2 – Actuator behaviour
- 3 – The event is triggered at activation
- 4 – Switching delay
- 5 – Action during occurrence of the event
- 6 – Action during cancellation of the event
- 7 – Switch-off delay

4.11.3 Examples of possible actions:





NOTE

The stated examples require the implementation of, among others, special sensor technology/actuators (e.g. window contacts, weather station, etc.)

Example 1: Window open warning

If the window in the children's room is open longer than 15 minutes, the user is informed via a push message on the smartphone.

Necessary devices: Window contact with binary input.

Precondition	Event	Action	Notification
-	 <p>Window contact</p> <p>Channel: Children's room Location: Upper floor > Children's room Event at: Window is being opened Delay: 900 seconds</p>	-	 <p>Window is not closed!</p> <p>The window in the children's room is open.</p>

Example 2: Party function

When the terrace door is being opened, the roller blind, if necessary, moves up and is locked. The lock prevents an unintentional lockout when the roller blinds move down at a specified time.

Necessary devices: Window contact with binary input blind actuator.



Precondition	Event	Action	Notification
-	 <p>Window contact</p> <p>Channel: Terrace door Location: Ground floor > kitchen Event at: Window is being opened</p>	 <p>Terrace door</p> <p>At: Occurrence of the event</p>  <p>Terrace door</p> <p>At: Cancellation of the event</p>	-

Example 3: Automatic ventilation

If a window is opened while blind is closed, the blind is to move up a certain distance.

Preparation: Create a scene which moves the blind to the desired ventilation position.

Necessary devices: Window contact with binary input blind actuator.



Precondition	Event	Action	Notification
Blind down	 <p>Window contact</p> <p>Channel: Terrace door Location: Ground floor > kitchen Event at: Window is being opened</p>	 <p>Blind 50%</p> <p>At: Occurrence of the event</p>	-

Example 4: Bathroom ventilation

The fan in the bathroom is to switch on three minutes after the light has been switched on and run on for five minutes after the light has been switched off.

Note: The switch-off delay defined in the event has the same effect as during the start of the event (the fan is switched on when the light is on for longer than 180 seconds) as during the end of the event (the fan is switched off 180 seconds after the light is switched off). If a switch-off delay has additionally been set in the actuator, the times are added until the actuator is actually switched off (in this case: 180 s + 120 s = 300 s = 5 minutes).

Necessary devices: Bathroom fan, switch actuator, sensor.

Precondition	Event	Action	Notification
-	 <p>Sensor</p> <p>Channel: Left rocker Location: Upper floor > corridor Event at: Switch-on Delay: 180 seconds</p>	 <p>Fan</p> <p>At: Occurrence of the event</p>  <p>Fan</p> <p>At: Cancellation of the event Delay: 120 seconds</p>	-



Example 5: Shading

If the outdoor temperature amounts to more than 27°C, and the brightness exceeds 50,000 lux, the blinds are to move to the shading position. As soon as the brightness value falls below the set value, the blinds move back to the UP position.

Preparation: Create a scene which moves the blind to the desired shading position.

Note: To prevent the blinds from moving too frequently, switching delays should be provided.

Necessary devices: Weather station, blind actuator.

Precondition	Event	Action	Notification
Outside temperature > 27°C	Brightness > 50,000 lx 5 minutes	 <p>Shading</p> <p>At occurrence of the event</p>  <p>All blinds</p> <p>At cancellation of the event Delay: 900 seconds</p>	-

4.12 Panels

In the panel configuration the buttons of the free@homeTouch 7" and the favourites bar (visible in the operating view of the app) can be freely equipped.

All panels installed in the system, as well as the favourites bar, can be selected from the bottom selection bar.



NOTE

Only panels appear that have been previously positioned on the floor plan under commissioning step "Allocation"!

The allocated actuator channels can be positioned on the panel via drag and drop from the list view.

After the confirmation the configuration is taken over and becomes visible on the device after a few seconds.



Fig. 38: Panel

4.13 Coupling of wireless devices with the System Access Point

free@home wireless devices must first be coupled with the System Access Point before they can be used in a project. The devices exchange a security key during the coupling process.

Communication between devices is carried out encrypted after coupling and they are firmly connected with the System Access Point. Coupled devices cannot be connected with a different System Access Point. They must first be reset to the factory settings.

Carry out the following steps to couple one or several devices with the system.

1. Install the free@home wireless device(s).
2. Use your smartphone, tablet or PC to call up the user interface of the System Access Point that is ready for use.
3. Switch on the mains power supply of the free@home wireless devices.

The devices are now in programming mode for 30 minutes.

4. In the user interface of the System Access Point select "System settings" > "free@home-Wireless" > "Search".

The System Access Point consecutively scans all free@home wireless devices. Devices that are in programming mode are integrated automatically into the system. The scanning process ends 10 minutes after the last device has been integrated.

Integrated devices are listed in the "Device list" of the user interface.

5. Use the serial numbers to check whether all installed devices have been found. If a device has not been found, reset it to the factory settings and start a new scanning process.

Possible reasons for not finding devices:

- The device is not in programming mode.
- The 30-minute programming time has expired.
- The device has already been coupled with a different system.

Resetting the wireless device to the factory settings

1. De-energize the free@home wireless device.
2. Keep the button at the bottom left pressed.
3. Re-energize the device.

The LED flashes slowly for 10 seconds, then fast for 5 seconds and then goes out.

The factory settings are restored and the device can now be programmed again.



NOTE

Devices which are already in factory settings are not reset again. The LED remains out in step 3.

4.14 myABB Living Space®

To operate the free@home outside the home network and to configure the access, up to the present required a DynDNS access and in-depth knowledge of networks.

With firmware update 2.0, free@home can now be connected to the myABB Living Space® portal. It can now be easily used to set up the system for mobile access.

The myABB Living Space® portal is a service from ABB. The portal offers the highest in operating comfort for remote access with smartphone and tablet. The end customer does not need DynDNS access. A connection is established by registering and logging in at myABB Living Space®.

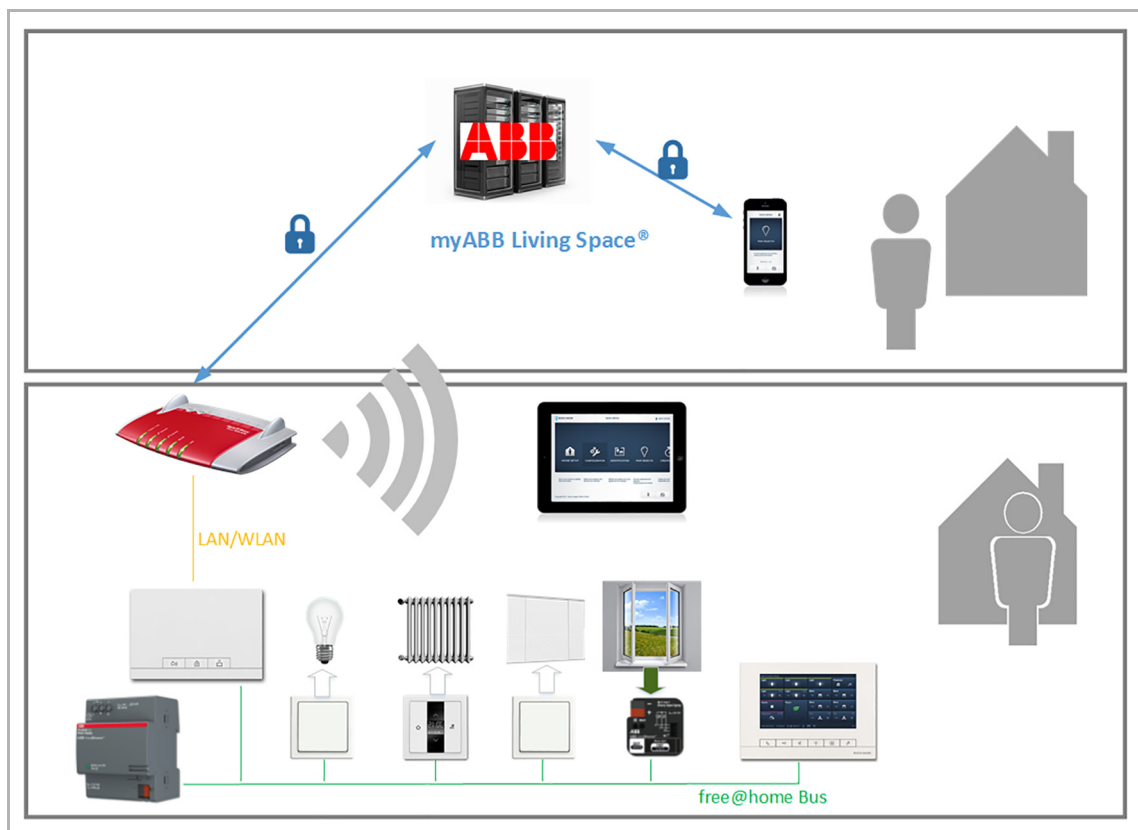

Fig. 39: myABB Living Space® Topology

myABB Living Space® serves as exchange between the local free@home installation and the mobile terminal device. Usage data and system states are neither stored nor can they be accessed by ABB. The communication between myABB Living Space® and the free@home, or the mobile terminal device is encrypted per TLS and the entire communication is additionally encrypted end-to-end.



NOTE

To prevent internal communication becoming visible on the Internet, no ports of routers are to be opened in the direction of the Internet.

A VPN tunnel or the myABB Living Space® portal is suitable for safe remote control.

TLS (Transport Layer Security) is a protocol for protecting personal data during the communication of users with applications on the Internet. During communication between server and client, TLS ensures that no unauthorized third party can bug or change this communication. TLS is the successor of the Secure Sockets Layer (SSL). Source: searchsecurity.de

End-to-end encryption means the encryption of transmitted data via all transmission stations. The data to be transmitted are encrypted on the senders end and only decrypted on the receivers end. This means that side-channel information, such as that partly necessary for controlling the transmission process, is not encrypted; on the other hand, intermediate stations with co-knowledge at which the transmitted content is received in clear text, are eliminated. Source: Wikipedia

Prerequisites for the use of myABB Living Space®:

Registration at myABB Living Space® (identical to ABB-Welcome® and can be dropped when a Welcome user account already exists).

Features:

- A free@home system can be coupled with a myABB Living Space® user account.
- A myABB Living Space® user account can be coupled with several free@home systems.
- A myABB Living Space® user account can be coupled with several mobile terminal devices (apps).
- Each user can obtain individual user rights (fitter/configurator/user).
- The free@home app can continue to be used without a myABB Living Space® user account (but then only with local access).

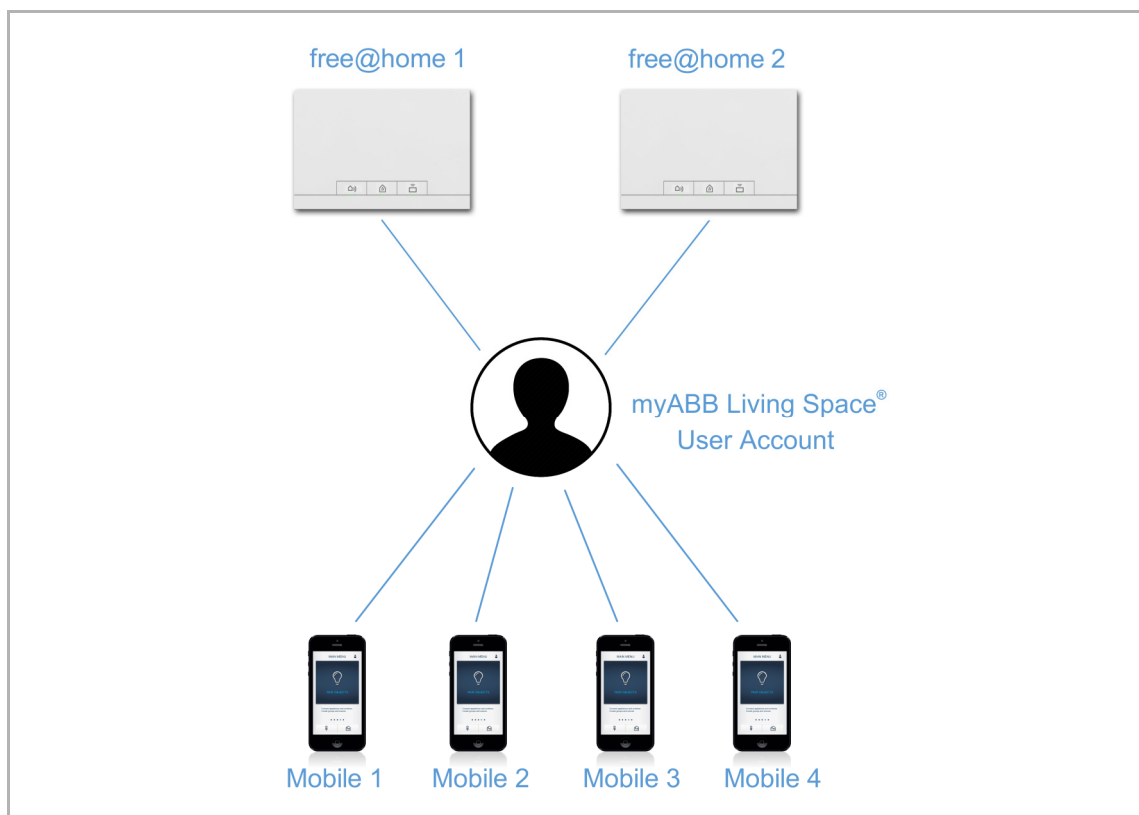

Fig. 40: Coupling with user account

Functions:

- All functions of the app you can use internal, are now also available mobile.
- The connection to myABB Living Space® makes it possible for the free@home system to send e-mails and push messages (see chapter 4.11 “Actions” on page 41).
- The authorization can be withdrawn from mobile terminal devices via the myABB Living Space® portal.
- Communication between the free@home system and a mobile terminal device is only transmitted via myABB Living Space® when the mobile terminal device is outside the local network.

Setup of myABB Living Space®:

1. Create a myABB Living Space® user account.
2. Couple the free@home system with the myABB Living Space® user account. Call up the free@home configuration user interface and enter the myABB Living Space® account data.
3. Couple the app of the mobile terminal device with the myABB Living Space® user account. Call up the free@home app and enter the myABB Living Space® account data.
4. Authorize the mobile terminal device on the free@home system (the authorization is carried out automatically when the mobile terminal device and the System Access Point are located in the same network).
5. Select the free@home system to be coupled in the app of the mobile terminal device.
 - The free@home configuration user interface displays a security token (electronic key).
6. Enter the security token in the free@home app (via manual input or by scanning a QR-code).

5 Types of Devices

5.1 Sensors and control elements

5.1.1 Control elements

Control elements can be used for the execution of different functions, e.g. switching and dimming lights, opening doors or moving blinds. Control elements can be configured for controlling individual functions or for the execution of group functions and scenes.

A control element consists of a 1gang or 2gang sensor unit, or a sensor/actuator unit and one or two rockers.

Sensor unit

A sensor unit serves as a pure control element, i.e. manual switching commands of the user are recorded and sent to the bus. Remote actuators can be switched via the configuration. Loads can not be switched directly.

Sensor/actuator unit

Aside from their function as control element, sensor/actuator units also serve as switch for the switching of loads. The sensors and switching channels are pre-programmed when supplied, i.e. after activating the bus line and connecting the load, the load can be switched directly on the control element.

Control element order items

The scope of delivery of a sensor unit, or a sensor/actuator unit, contains only the electronic insert. It must be completed with a suitable rocker and a cover frame.

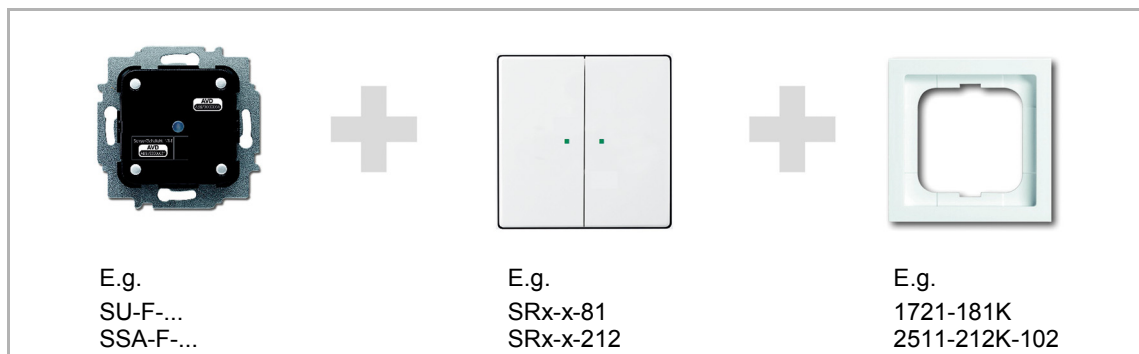

Fig. 41: Control element order items

Article no.	Product name	Sensor channels
SU-F-1.0.1 SU-F-1.0.1-WL ^{*)}	Sensor unit, 1gang	1
SU-F-2.0.1 SU-F-2.0.1-WL ^{*)}	Sensor unit, 2gang	2

Table 4: Sensor units

^{*)} Wireless device

















Article no.	Product name	Sensor channels	Actuator channels	Switching load
SSA-F-1.1.1 SSA-F-1.1.1-WL ^{*)}	Sensor/switch actuator 1/1gang	1 	1 	1 x 2300 W
SSA-F-2.1.1 SSA-F-2.1.1-WL ^{*)}	Sensor/switch actuator 2/1gang	2 	1 	1 x 2300 W
SSA-F-2.2.1 SSA-F-2.2.1-WL ^{*)}	Sensor/switch actuator 2/2gang	2 	2 	2 x 1200 W
SDA-F-1.1.1 SDA-F-1.1.1-WL ^{*)}	Sensor/dimming actuator 1/1gang	1 	1 	1 x 180 W
SDA-F-2.1.1 SDA-F-2.1.1-WL ^{*)}	Sensor/dimming actuator 2/1gang	2 	1 	1 x 180 W
SBA-F-1.1.1 SBA-F-1.1.1-WL ^{*)}	Sensor/blind actuator 1/1gang	1 	1 	4 A, $\cos\phi = 0.5$
SBA-F-2.1.1 SBA-F-2.1.1-WL ^{*)}	Sensor/blind actuator 2/1gang	2 	1 	4 A, $\cos\phi = 0.5$
SA-M-8.8.1	Sensor/switch actuator 8/8gang	8 	8 	8 x 6 A

Table 5: Sensor/actuator units
*) Wireless device



NOTE

Please see the electronic catalogue for all possible switch ranges (www.busch-jaeger-catalogue.com).

Rockers for control elements

The rockers of the control elements are available for the switch ranges solo, future, carat, Busch-axcent, and SI in the colours studio white, anthracite, aluminium silver, as well as white and alpine white. Depending on their use, the rockers can be selected with different printing.

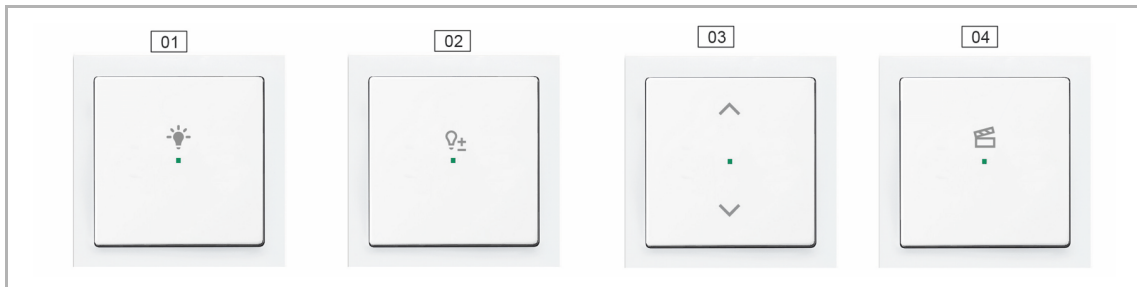

Fig. 42: Rockers for control elements

- 01 – Light icon
- 02 – Dimmer icon
- 03 – Blind icon
- 04 – Scene icon

Button function

All control elements are supplied in "Rocker" operating mode ex factory. This means:

- Operation on the top activates or gives a movement up command,
- Operation on the bottom deactivates or gives a movement down command.

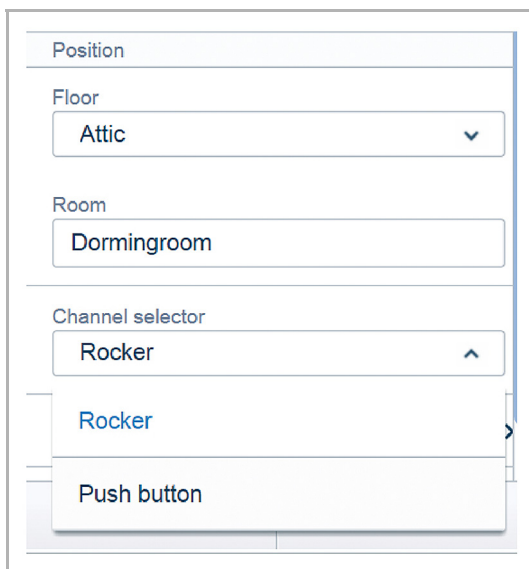

Fig. 43: Button function

The operating mode can also be changed to "Push-button" mode via the channel selection of the respective sensor in the "Device settings". The control element then acts as two separate push-buttons. This means:

- Operation on top switches on.
- Repeat of operation on top switches off.

Example of application:

The control element is to switch a scene. A scene can only be triggered but not switched on or off. When parameterized as push-button, a sensor can activate two different scenes.



NOTE

The setting becomes visible only after the sensor has been positioned in the allocation.

After the changeover a separate sensor channel icon is displayed on the floor plan for each of the push-buttons!

LED as light for orientation

Each rocker of a sensor has an LED. At the point of delivery this LED is configured as light for orientation. This means:

- The LED lights up permanently to ensure that the sensor is easy to locate in the dark.

The brightness of the LED can be changed or totally deactivated in the device settings.

LED as status display

For the status indication the LED of the rocker can be re-configured in the device settings. When the sensor is linked with an actuator, the LED signals whether the actuator is on or off.

The clear indication of the actuator status is guaranteed as long as only one sensor is linked with one or several actuators or several sensors activate an identical group of actuators.

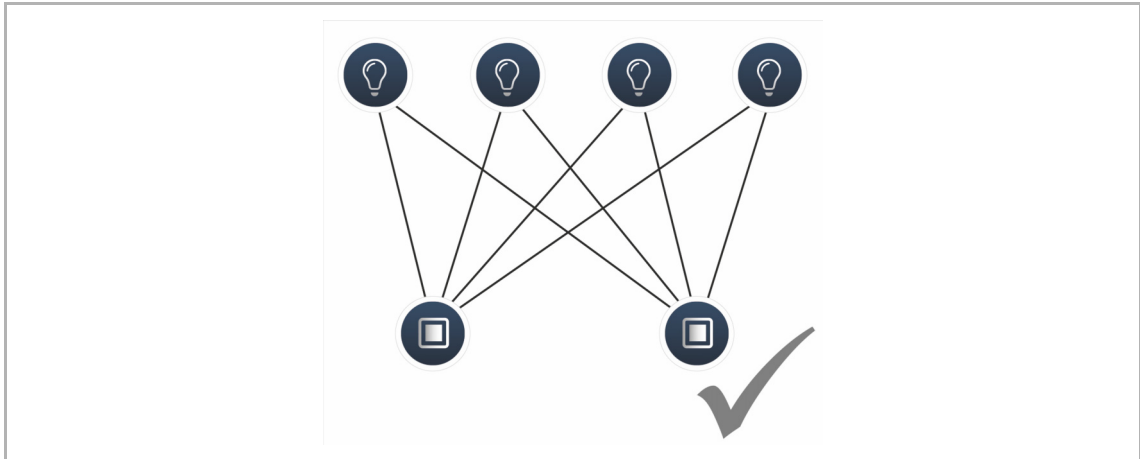

Fig. 44: LED function - Status indication possible

If several sensors activate different groups of actuators the correct indication of the actuator status is no longer guaranteed.

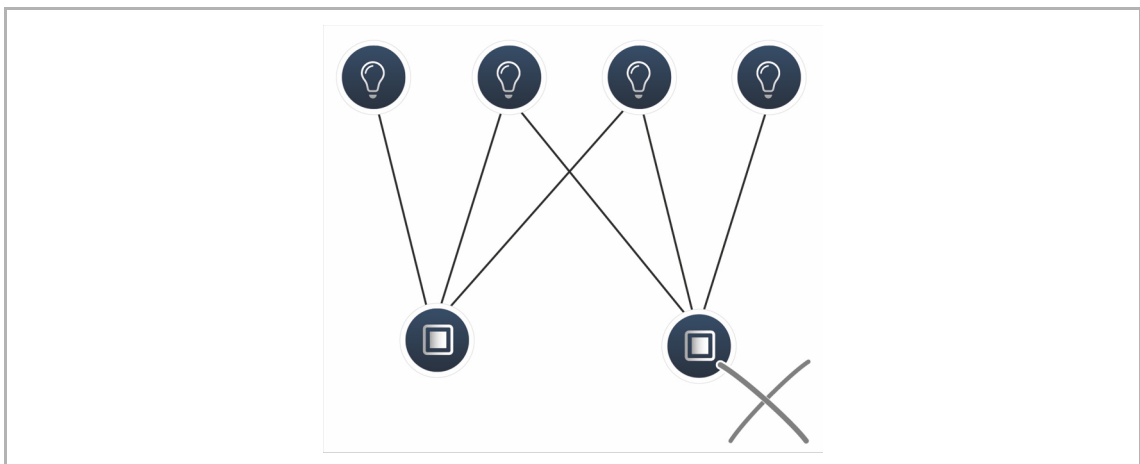

Fig. 45: LED function - Status indication is not possible

Parameter settings of 1/1gang sensor/switch actuator

Actuator settings

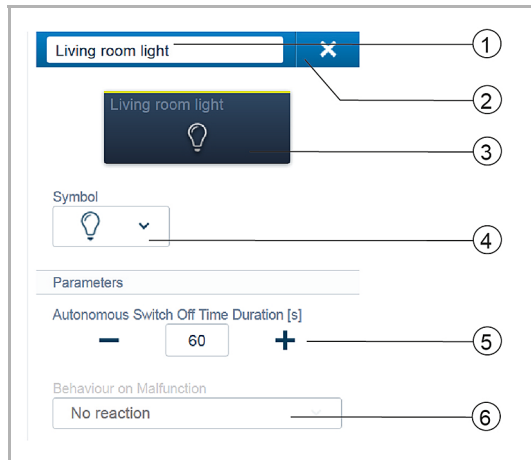

Fig. 46: Actuator settings

- [1] Changing the name
- [2] Deleting the channel
- [3] Switching of the actuator via the button
- [4] Selection of a different icon
- [5] Setting the switch-off delay in seconds
 - The -/+ buttons can be used to specify, for example, how long the light remains switched on after the actuator has deactivated the load.
- [6] Behaviour during faults
 - Display of information only. No settings are possible.



NOTE

The function of the actuator can be specified after the allocation: Switch actuator, heating operation, additional heating stage or trigger.

Sensor settings



Fig. 47: Sensor settings

- [1] Changing the name
- [2] Deleting the channel
- [3] Selecting the rocker in the list view

Rocker settings

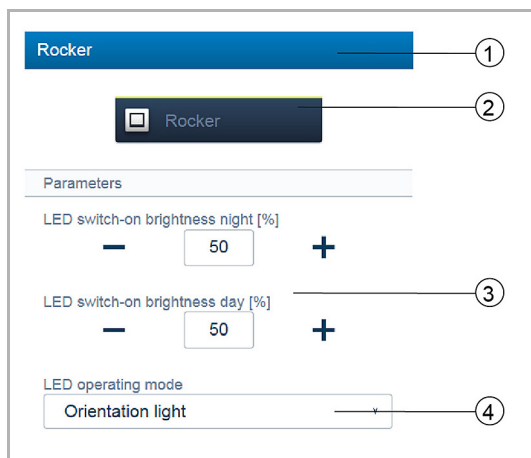

Fig. 48: Rocker settings

- [1] Changing the name
- [2] Switching of the sensor via the button
- [3] Setting the LED night/day switch-on brightness in % via the -/+ buttons
 - The parameter specifies how strong the LED lights up percentage wise during night/day.

NOTE

The parameter only functions when a time profile with the application "LED day/night switchover" is available. The device (channel) must be linked with this application.



Icon of the application

- [4] Selecting the LED operating mode:
 - Light for orientation: LED lights up permanently
 - Status display: LED lights up during actuation

The following parameter is available immediately for pre-programmed devices. For all other devices it becomes available only after being linked with an actuator. The setting in the list view is then made via the linking function of the Web-based user interface of the System Access

Point.

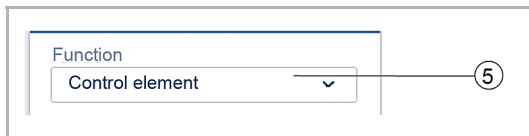

Fig. 49: Rocker setting after linking with actuator

[5] Selecting the function:

- Control element
- Dimming sensor
- Staircase light sensor
- Force-position sensor On/Off
- Blind sensor
- Blind force-position
- Scene sensor (is visible only when the "Scene sensor" has been selected.
Long press of the button: "Overwrite scene"/"Retain scene")

Parameter settings of 2/1gang sensor/switch actuator

Actuator settings

As for 1/1gang.

Sensor settings

As for 1/1gang. However, two rockers (left and right rocker) are displayed in the list view.

Rocker settings

As for 1/1gang. However, the settings are made for two rockers (left rocker and right rocker).

Parameter settings of 2/2gang sensor/switch actuator

Actuator settings

As for 1/1gang. However, two actuator channels are available.

Sensor settings

As for 1/1gang. However, two rockers (left and right rocker) are displayed in the list view.

Rocker settings

As for 1/1gang. However, the settings are made for two rockers (left rocker and right rocker).

Parameter settings of 1/1gang sensor/dimming actuator

Actuator settings

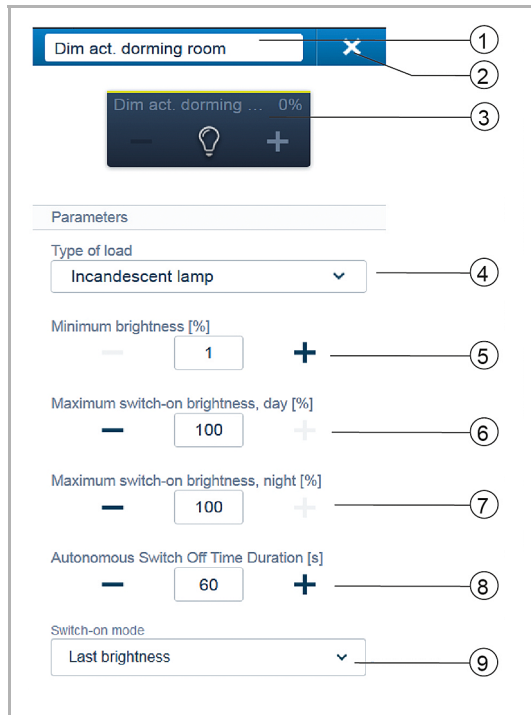

Fig. 50: Actuator settings

- [1] Changing the name
- [2] Deleting the channel
- [3] Switching of the actuator via the button.
Dimming the actuator via the -/+ buttons
- [4] Setting of the load connected to the actuator.
Selecting the function:
 - Automatic load detection
 - Inductive load
 - Dimmable LED/KLL
 - Incandescent lamp
- [5] Setting the minimum brightness in % via the -/+ buttons
- [6] Setting the maximum switch-on brightness during the day in % via the -/+ buttons
- [7] Setting the maximum switch-on brightness during the night in % via the -/+ buttons
- [8] Setting the switch-off delay in seconds
 - The -/+ buttons can be used to specify, for example, how long the light remains switched on after the actuator has deactivated the load.
- [9] Setting the switch-on mode
 - The parameter specifies whether the lamp switches on with the previously set brightness or always with maximum brightness.

Sensor settings

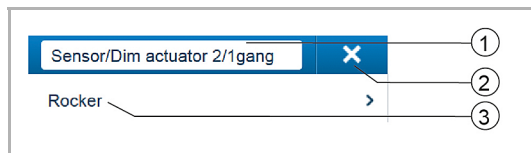

Fig. 51: Sensor settings

- [1] Changing the name
- [2] Deleting the channel
- [3] Selecting the rocker in the list view

Rocker settings

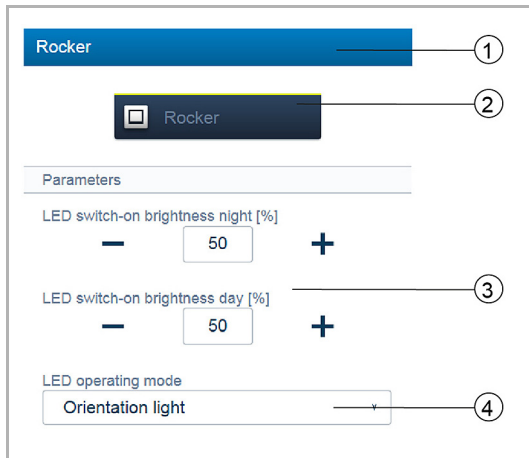

Fig. 52: Rocker settings

- [1] Changing the name
- [2] Switching of the sensor via the button
- [3] Setting the LED night/day switch-on brightness in % via the +/- buttons
 - The parameter specifies how strong the LED lights up percentage wise during night/day.

NOTE

The parameter only functions when a time profile with the application "LED day/night switchover" is available. The device (channel) must be linked with this application.



Icon of the application

- [4] Selecting the LED operating mode:
 - Light for orientation: LED lights up permanently
 - Status display: LED lights up during actuation

The following parameter is available immediately for pre-programmed devices. For all other devices it becomes available only after being linked with an actuator. The setting in the list view is then made via the linking function of the Web-based user interface of the System Access Point.



Fig. 53: Rocker setting after linking with actuator

- [5] Selecting the function:
 - Control element
 - Dimming sensor
 - Staircase light sensor
 - Force-position sensor On/Off
 - Blind sensor
 - Blind force-position
 - Scene sensor (is visible only when the "Scene sensor" has been selected.
Long press of the button: "Overwrite scene"/"Retain scene")

Parameter settings of 2/1gang sensor/dimming actuator

Actuator settings

As for 1/1gang.

Sensor settings

As for 1/1gang. However, two rockers (left and right rocker) are displayed in the list view.

Rocker settings

As for 1/1gang. However, the settings are made for two rockers (left rocker and right rocker).

Parameter settings of 1/1gang sensor/blind actuator

Actuator settings

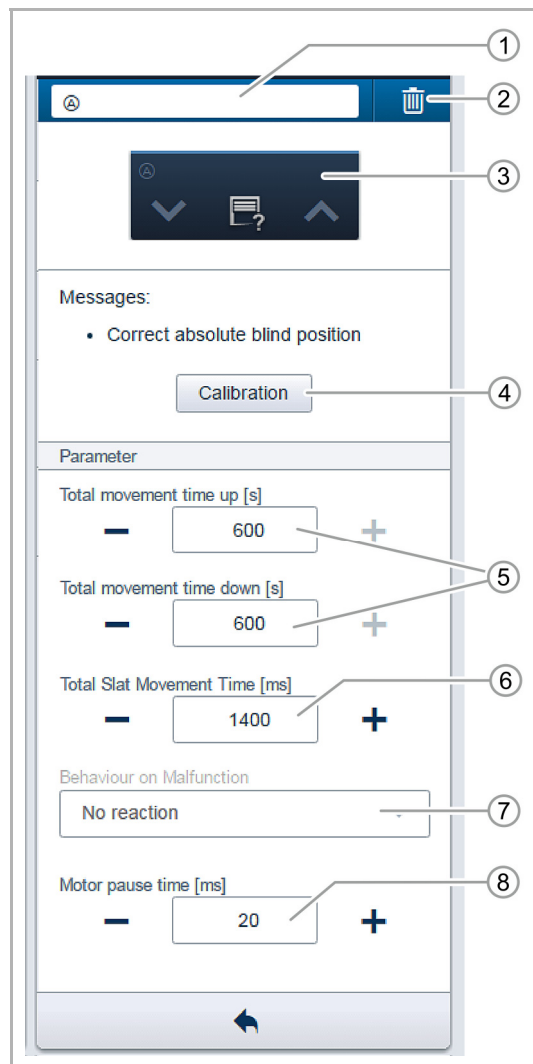

Fig. 54: Actuator settings

- [1] Changing the name
- [2] Deleting the channel
- [3] Switching the actuator via the v \wedge buttons
- [4] Button "Calibration"
 - A wizard guides you through the calibration process. For a detailed description see the online Help of the System Access Point.
- [5] Setting the movement time up/down in seconds via the -/+ buttons
- [6] Setting the movement time of the slats in seconds via the -/+ buttons
- [7] Behaviour during faults
 - Display of information only. No settings are possible.
- [8] Setting the motor pause time in milliseconds
 - Please check the operating manual of the blind motor for specifying the correct pause time of the motor (period between switching the actuator and start-up of the motor). This value is required for the setting of the slats.

Sensor settings

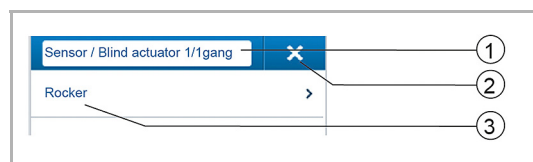

Fig. 55: Sensor settings

- [1] Changing the name
- [2] Deleting the channel
- [3] Selecting the rocker in the list view

Rocker settings

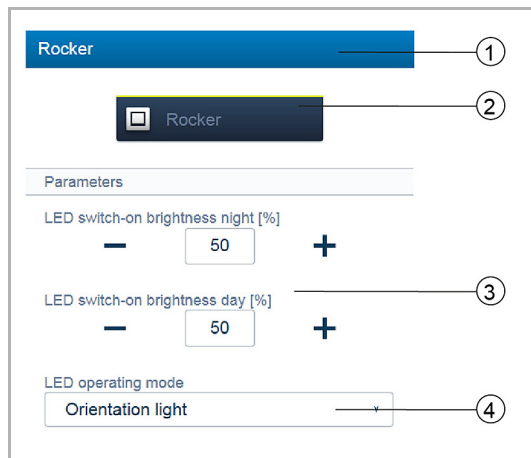

Fig. 56: Rocker settings

- [1] Changing the name
- [2] Switching of the sensor via the button
- [3] Setting the LED night/day switch-on brightness in % via the -/+ buttons
 - The parameter specifies how strong the LED lights up percentage wise during night/day.

NOTE

The parameter only functions when a time profile with the application "LED day/night switchover" is available. The device (channel) must be linked with this application.



Icon of the application

- [4] Selecting the LED operating mode:
 - Light for orientation: LED lights up permanently
 - Status display: LED lights up during actuation

The following parameter is available immediately for pre-programmed devices. For all other devices it becomes available only after being linked with an actuator. The setting in the list view is then made via the linking function of the Web-based user interface of the System Access Point.



Fig. 57: Rocker setting after linking with actuator

- [5] Selecting the function:
 - Control element
 - Dimming sensor
 - Staircase light sensor
 - Force-position sensor On/Off
 - Blind sensor
 - Blind force-position
 - Scene sensor (is visible only when the "Scene sensor" has been selected.
Long press of the button: "Overwrite scene"/"Retain scene")

Parameter settings of 2/1gang sensor/blind actuator

Actuator settings

As for 1/1gang.

Sensor settings

As for 1/1gang. However, two rockers (left and right rocker) are displayed in the list view.

Rocker settings

As for 1/1gang. However, the settings are made for two rockers (left rocker and right rocker).

Parameter settings of 1gang sensor unit

Sensor settings

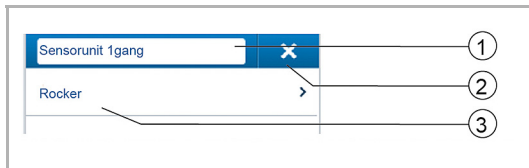

Fig. 58: Sensor settings

- [1] Changing the name
- [2] Deleting the channel
- [3] Selecting the rocker in the list view

Rocker settings

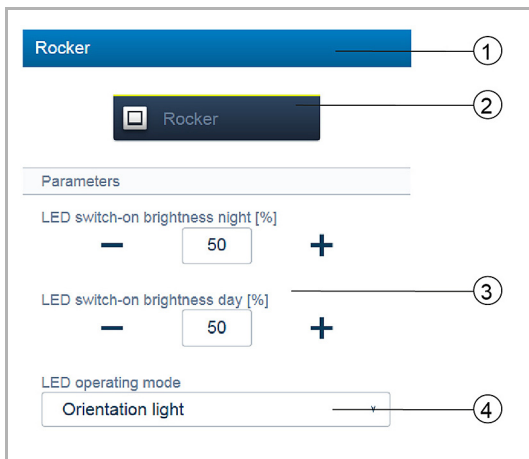

Fig. 59: Rocker settings

- [1] Changing the name
- [2] Switching of the sensor via the button
- [3] Setting the LED night/day switch-on brightness in % via the -/+ buttons
 - The parameter specifies how strong the LED lights up percentage wise during night/day.

NOTE

The parameter only functions when a time profile with the application "LED day/night switchover" is available. The device (channel) must be linked with this application.



Icon of the application

- [4] Selecting the LED operating mode:
 - Light for orientation: LED lights up permanently
 - Status display: LED lights up during actuation

The following parameter is available immediately for pre-programmed devices. For all other devices it becomes available only after being linked with an actuator. The setting in the list view is then made via the linking function of the Web-based user interface of the System Access Point.

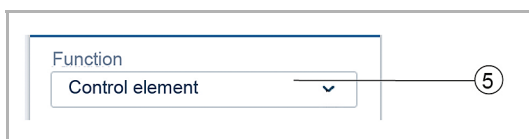

Fig. 60: Rocker setting after linking with actuator

- [5] Selecting the function:
 - Control element
 - Dimming sensor
 - Staircase light sensor
 - Force-position sensor On/Off
 - Blind sensor
 - Blind force-position
 - Scene sensor (is visible only when the "Scene sensor" has been selected. Long press of the button: "Overwrite scene"/"Retain scene")

Parameter settings of 2gang sensor unit

Sensor settings

As for 1/1gang. However, two rockers (left and right rocker) are displayed in the list view.

Rocker settings

As for 1/1gang. However, the settings are made for two rockers (left rocker and right rocker).

5.1.2 Movement detector

Movement detectors detect movement in their surveillance area and send this information to the free@home bus. This allows automated functions to be executed, e.g. switch a light or a scene.

The movement detector also has a brightness sensor, which measures the ambient brightness. This ensures, for example, that light is switched on only when it is actually required. The threshold value from which the movement detector is to switch can be programmed in the user interface.

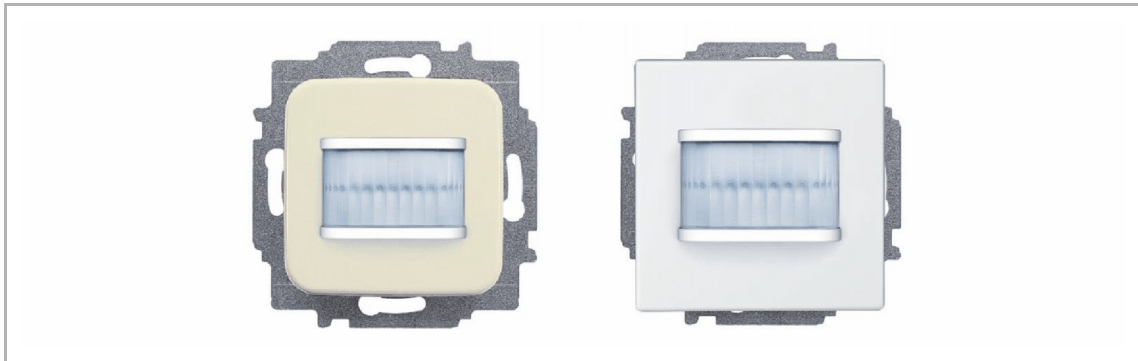

Fig. 61: Movement detector

Detection range

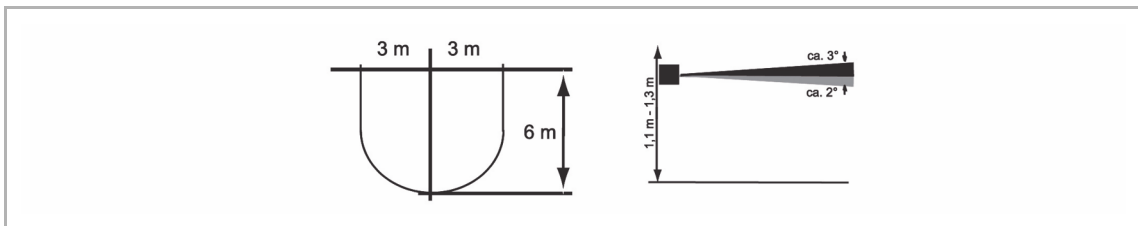

Fig. 62: Detection range

Movement detector (Sensor)

The movement detector (Sensor) serves only for the detection of movement, i.e. movements of the user are recorded and sent to the bus. Remote actuators can be switched via the configuration. Loads can not be switched directly.

Movement detector/actuator unit

Aside from their function as movement detector, movement detector/actuator units also serve as switch for the switching of loads. The sensors and switching channels are pre-programmed when supplied, i.e. after activating the bus line and connecting the load, the load can be switched directly via the movement detector.

When supplied, the movement detector operates dependent on brightness, i.e. it switches only in the dark. The switching behaviour can be changed in the user interface.

Movement detector order items

The scope of delivery of the movement detector contains only the electronic insert. It must still be completed with a cover frame.



Fig. 63: Movement detector order items





Article no.	Product name	Program	Colour	Sensor channels
MD-F-1.0.1-212	Movement detectors	Busch-Duro 2000® SI	White	1 
MD-F-1.0.1-214	Movement detectors	Reflex SI	Alpine white	1 
MD-F-1.0.1-81	Movement detectors	future® linear solo®, carat® Busch-axcent®	Anthracite	1 
MD-F-1.0.1-83	Movement detectors	future® linear solo®, carat® Busch-axcent®	Aluminium silver	1 
MD-F-1.0.1-84	Movement detectors	future® linear solo®, carat® Busch-axcent®	Studio white	1 

Table 6: Movement detectors (Sensors)











Article no.	Product name	Program	Colour	Sensor channels	Actuator channels
MSA-F-1.1.1-212 MSA-F-1.1.1-212-WL ^{*)}	Movement detector/switch actuator, 1gang	Busch-Duro 2000 [®] SI	White	1 	1 
MSA-F-1.1.1-214 MSA-F-1.1.1-214-WL ^{*)}	Movement detector/switch actuator, 1gang	Reflex SI	Alpine white	1 	1 
MSA-F-1.1.1-81 MSA-F-1.1.1-81-WL ^{*)}	Movement detector/switch actuator, 1gang	future [®] linear solo [®] , carat [®] Busch-axcent [®]	Anthracite	1 	1 
MSA-F-1.1.1-83 MSA-F-1.1.1-83-WL ^{*)}	Movement detector/switch actuator, 1gang	future [®] linear solo [®] , carat [®] Busch-axcent [®]	Aluminium silver	1 	1 
MSA-F-1.1.1-84 MSA-F-1.1.1-84-WL ^{*)}	Movement detector/switch actuator, 1gang	future [®] linear solo [®] , carat [®] Busch-axcent [®]	Studio white	1 	1 

Table 7: Movement detector/actuator units
*) Wireless device

Article no.	Product name	Switching load
MSA-F-1.1.1-212 MSA-F-1.1.1-212-WL ^{*)}	Movement detector/switch actuator, 1gang	1 x 2300 W
MSA-F-1.1.1-214 MSA-F-1.1.1-214-WL ^{*)}	Movement detector/switch actuator, 1gang	1 x 2300 W
MSA-F-1.1.1-81 MSA-F-1.1.1-81-WL ^{*)}	Movement detector/switch actuator, 1gang	1 x 2300 W
MSA-F-1.1.1-83 MSA-F-1.1.1-83-WL ^{*)}	Movement detector/switch actuator, 1gang	1 x 2300 W
MSA-F-1.1.1-84 MSA-F-1.1.1-84-WL ^{*)}	Movement detector/switch actuator, 1gang	1 x 2300 W

Table 8: Switching loads
*) Wireless device



NOTE

Please see the electronic catalogue for all possible switch ranges (www.busch-jaeger-catalogue.com).

Parameter settings of movement detectors/switch actuators, 1gang

Actuator settings

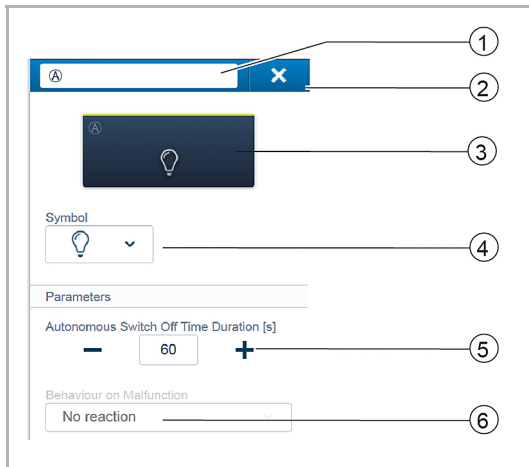

Fig. 64: Actuator settings

- [1] Changing the name
- [2] Deleting the channel
- [3] Switching of the actuator via the button
- [4] Selection of a different icon
 - The -/+ buttons can be used to specify, for example, how long the light remains switched on after the actuator has deactivated the load.
- [6] Behaviour during faults
 - Display of information only. No settings are possible.

Sensor settings (movement detector)

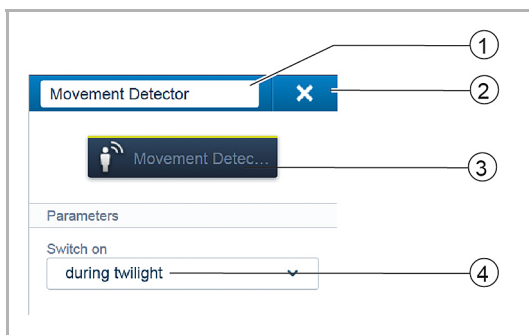

Fig. 65: Sensor settings - Movement detector

- [1] Changing the name
- [2] Deleting the channel
- [3] Switching of the actuator via the button
- [4] Selection of the brightness conditions at which the device is to respond. Activation:
 - independent of the brightness
 - during twilight
 - during darkness

Parameter settings of movement detector (sensor)

Sensor settings (movement detector)

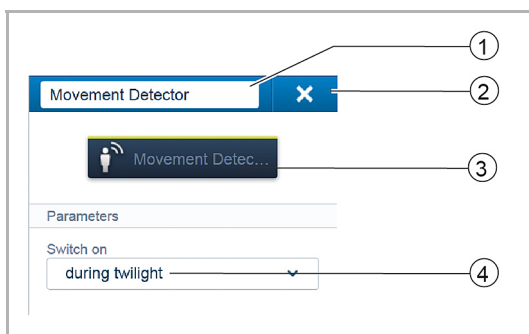

Fig. 66: Sensor settings - Movement detector

- [1] Changing the name
- [2] Deleting the channel
- [3] Switching of the actuator via the button
- [4] Selection of the brightness conditions at which the device is to respond. Activation:
 - independent of the brightness
 - during twilight
 - during darkness

5.1.3 Room temperature controller

The room temperature controller (RTC) always displays the set-point temperature. This can be changed via the arrow keys of the control element.

The RTC operates as PI controller and in time adjusts its control value also to the response of the room.

The device has four operating modes that can be adjusted locally:

Comfort operation

Application: You are in the room for a longer period of time. The comfort temperature is to be reached.

Behaviour of the RTC: The display indicates the set-point temperature that has been set. The controller aims at this temperature.

Eco mode

Application: You leave the room for a few hours. The room temperature is to be reduced to save energy. However, the room is not to cool down.

Behaviour of the RTC: The display indicates "ECO". The temperature is reduced by 4°C (the reduction can be adjusted in the user interface).

Off mode

Application: The room is not being used for a longer period of time.

Behaviour of the RTC: The display indicates "OFF". The heating valves are closed (frost protection is active).

Antifreeze mode

Application: The frost protection switches on automatically when the window is opened (a window contact is required).

Behaviour of the RTC: The display indicates antifreeze. The heating valves close. If the room temperature drops below 7°C, the heating is switched on. This is to prevent damage to the building.

Heating/cooling switchover

The RTC is suitable both for heating and cooling operation. The switchover of the two modes is made via a binary input. The input is configured as heating/cooling reverser and is connected with the room temperature controller in the user interface.

Extension unit operation

The RTC can be configured in the device settings as extension unit. In this setting only the temperature sensor of the main unit is evaluated. The extension unit serves only for selecting the operating modes or the set-point temperature.

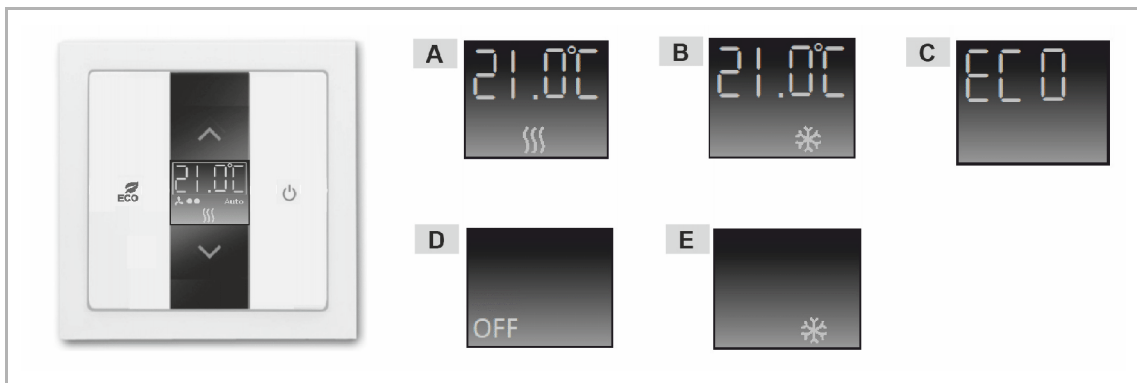

Fig. 67: Display of room temperature controller (RTC)

- A – Comfort mode heating
- B – Comfort mode cooling
- C – ECO mode
- D – OFF mode
- E – Antifreeze mode

Order items of room temperature controller

The scope of delivery of the room temperature controller contains only the electronic insert. It must still be completed with a cover plate and a cover frame.

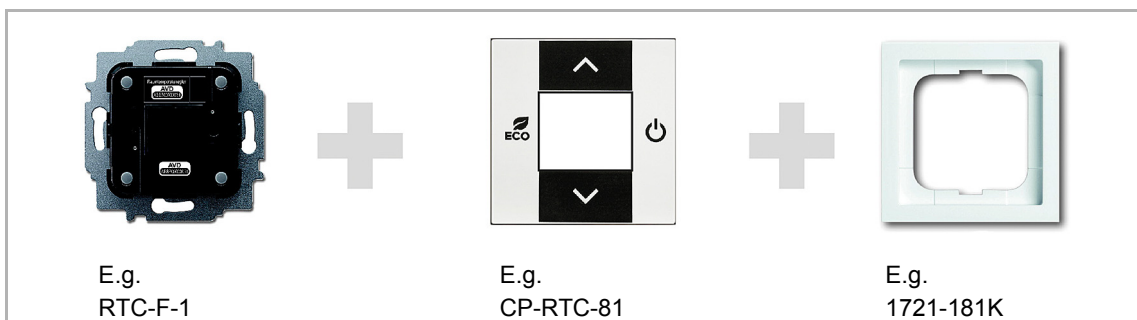

Fig. 68: Order items of room temperature controller

Article no.	Product name	Sensor channels
RTC-F-1 RTC-F-1-WL ^{*)}	Room temperature controller	1

Table 9: Room temperature controller (sensor)
*) Wireless device

Article no.	Product name	Sensor channels	Actuator channels
RTC-F-2.1-1-WL ^{*)}	Room temperature controller	1	1

Table 10: Room temperature controller (sensor/switch actuator)
*) Wireless device

Article no.	Program	Colour
CP-RTC-81	future [®] linear solo [®] , carat [®] Busch-axcent [®]	Anthracite
CP-RTC-83	future [®] linear solo [®] , carat [®] Busch-axcent [®]	Aluminium silver
CP-RTC-84	future [®] linear solo [®] , carat [®] Busch-axcent [®]	Studio white
CP-RTC-212	Reflex SI	White
CP-RTC-214	Reflex SI	Alpine white

Table 11: Cover plates for room temperature controller



NOTE

Please see the electronic catalogue for all possible switch ranges (www.busch-jaeger-catalogue.com).

Parameter settings of room temperature controller

Actuator settings

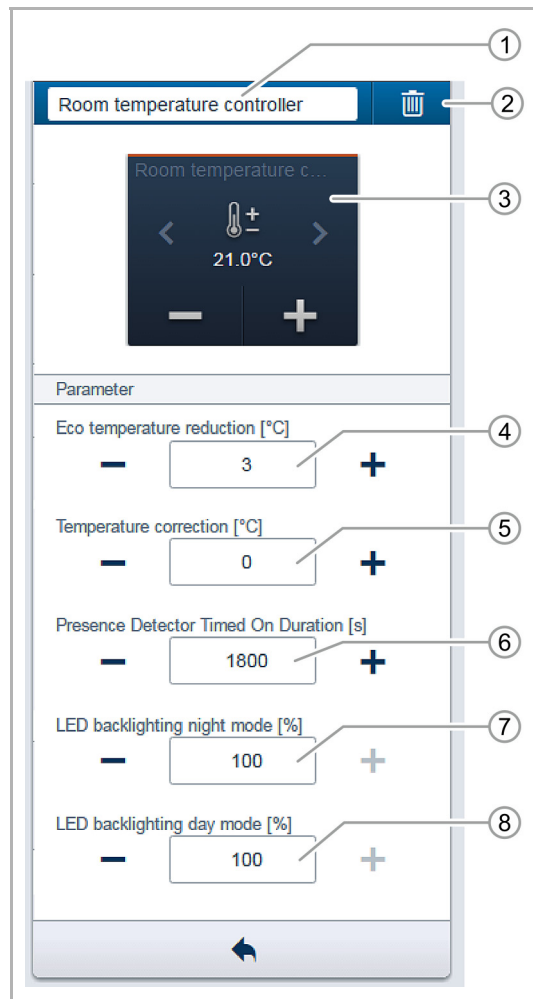

Fig. 69: Actuator settings - RTC

- [1] Changing the name
- [2] Deleting the channel
- [3] Switching of the actuator via the button
- [4] Setting the Eco temperature reduction in °C
 - The +/- buttons can be used to specify the value the temperature is to be reduced to when ECO mode is activated.
- [5] Setting the temperature correction in °C via the +/- buttons.
 - Manual increase/reduction of the temperature value if the temperature is repeatedly not reached automatically.
- [6] Setting the switch-off delay in seconds during absence via the +/- buttons
 - The parameter specifies up to when the ECO mode is activated after exiting the room, when the ECO mode has been deactivated by a movement detector.
- [7] Setting the LED backlighting for night mode via the +/- buttons
 - Manual increase/reduction of the switch-on brightness.
- [8] Setting the LED backlighting for day mode via the +/- buttons
 - Manual increase/reduction of the switch-on brightness.

5.1.4 Displays

free@homeTouch 7"

The free@homeTouch 7" serves as indoor video station for the ABB-Welcome® door communication system and for the central control of free@home functions, such as centrally moving all blinds, switching scenes, or controlling room temperature controllers (as extension unit).



Fig. 70: free@homeTouch 7"

The panel is connected to both bus systems, the free@home bus and the ABB-Welcome® bus. The audio/video signals are transmitted and the device is supplied with power exclusively via the ABB-Welcome® bus. The panel can therefore also be used as a pure indoor video station without a connection to the free@home system.

It is not possible to operate the panel without being connected to the ABB-Welcome® bus. To ensure the power supply to the panel, at least one ABB-Welcome® system controller or one auxiliary power supply is required.



NOTE

Separate cabling is required from the ABB-Welcome® bus and free@home bus.

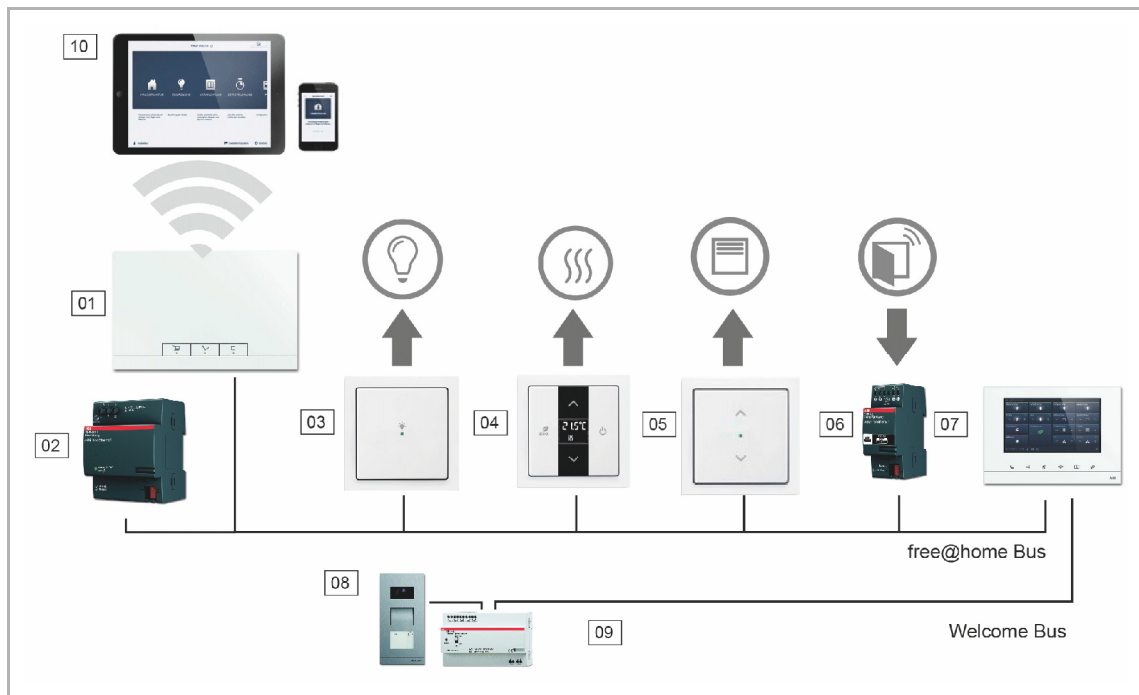

Fig. 71: System setup of ABB-free@home® with ABB-Welcome®

- 01 – System Access Point
- 02 – Power supply of free@home bus
- 03 – Sensor/switching actuator unit
- 04 – Room temperature controller
- 05 – Sensor/blind actuator unit
- 06 – Window contact
- 07 – free@homeTouch 7"
- 08 – Outdoor station
- 09 – Power supply of ABB-Welcome® bus
- 10 – Tablet/smartphone

Up to 16 free@home functions can be positioned on the free@home operating page. The room temperature controller function occupies two function positions. Programming is carried out via the user interface of the System Access Point.

In addition, the panel acts as gateway which mutually compiles the telegrams of the two bus systems. This, for example, makes it possible to switch an actuator in the ABB-Welcome® system during an incoming door call of the free@home system, or to use a sensor in the free@home system to send an "Open door" command to the ABB-Welcome® system.

Each of these functions appears as separate entry in the "Allocation" area. The functions can be positioned on the floor plan and then, like any other sensor or actuator, connected in the "Linking" area with other sensors and actuators.

The "Door call" function offers four linking functions for each of the four possible ABB-Welcome® outdoor stations. This allows specific actions to be configured separately for each entrance of the house. These are triggered as soon as the visitor rings the bell at one of the outdoor stations.

The "Door opener" function offers five linking functions: One of the four possible door openers of the ABB-Welcome® system can be specifically activated (to open a special door with the sensor). Or a door opener can be defined which dynamically opens the door from which a call is made (all doors can be opened with one sensor, depending from where the bell call comes).

Icon	Information	
	Name:	Floor call
	Type:	Sensor
	Made available by:	free@homeTouch 7"
	Function:	Signals an incoming floor call
	Application:	A free@home actuator is to switch at an incoming floor call
	Name:	Floor call button
	Type:	Actuator
	Made available by:	free@homeTouch 7"
	Function:	Triggers a floor call
	Application:	A free@home sensor is to be used as floor call button
	Name:	Corridor light
	Type:	Actuator
	Made available by:	free@homeTouch 7"
	Function:	Switches the corridor switch contact of the Welcome system controller
	Name:	Automatic door opener
	Type:	Actuator
	Made available by:	free@homeTouch 7"
	Function:	Activates/deactivates the automatic door opener
	Application:	A free@home sensor is to activate/deactivate the automatic door opener
	Name:	Door opener
	Type:	Actuator
	Made available by:	free@homeTouch 7"
	Function:	Actuates the door opener of the ABB-Welcome® system
	Application:	A free@home sensor is to actuate the door opener
	Name:	Door call
	Type:	Sensor
	Made available by:	free@homeTouch 7"
	Function:	Signals an incoming door call
	Application:	A free@home actuator is to switch at an incoming door call

Table 12: Display icons

Display order items

Article no.	Product name	Colour	Display diagonal
DP7-S-611	ABB-free@home® Touch 7"	White	17.8 cm (7")
DP7-S-625	ABB-free@home® Touch 7"	Black	17.8 cm (7")

Table 13: Displays

5.2 Binary inputs

With the aid of binary inputs, information of switch contacts can be used outside of the free@home system. For example, they can retract the awning at a wind alarm from a weather station, or integrate window contacts to switch off the heating in the room automatically. The type of sensor connected to the binary input must be defined in the user interface.

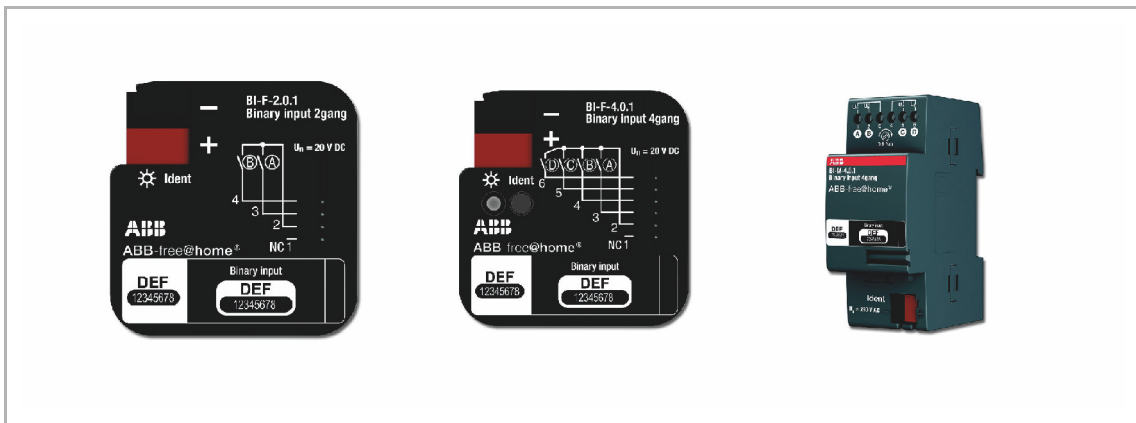
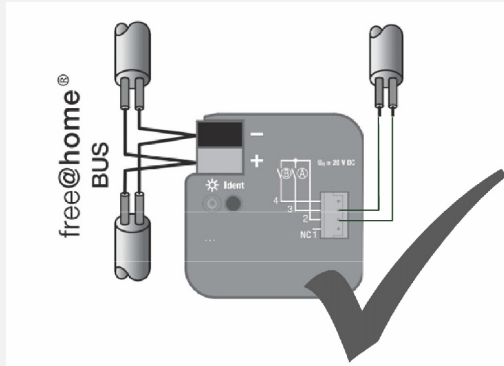

Fig. 72: Binary inputs

Each binary input makes the following types of sensors available for selection:

Push-button interface	Integrates a conventional switch or push-button.
Window contact	<p>When connected with a room temperature controller the heating is shut off when the window is open.</p> <p>Routing the polling contacts in a separate conduit:</p> 
Rain alarm	When connected with a blind actuator, it will retract the blind/awning at a rain alarm.

Frost alarm	When linked with a blind actuator, the blind/awning will be retracted or extended.
Wind alarm	When linked with a blind actuator, the blind/awning is retracted (with wire-break protection, i.e. the wind alarm is triggered when the contact is open).
Cold/warm switchover	When linked with a heating actuator the controller switches between heating and cooling operation.

Table 14: Sensor types at the binary inputs

Parameter settings

The functions of the binary inputs can be fixed as follows:







































- Control element
- Dimming sensor
- Blind sensor
- Staircase light sensor
- Frost alarm
- Force-position sensor On/Off
- Blind force-position
- Switchover heating/cooling
- Wind alarm
- Scene sensor

Binary input order items

Article no.	Product name	Construction type	Input voltage	Input voltage
BI-F-2.0.1	Binary input, 2gang	Pellet	20 V DC	0.5 mA
BI-F-4.0.1	Binary input, 4gang	Pellet	20 V DC	0.5 mA
BI-M-4.0.1	Binary input, 4gang	Rail-mounting	10 to 230 V AC/DC	1 mA

Table 15: Binary inputs

Settings free@home

Icon	Function	Contact type	Sensor type	Switching behaviour		
				On	Off	Description
	Control element	NOC	Push-button			-
		NOC	Switch			
		NCC	Push-button			
		NCC	Switch			
	Dimming sensor	NOC	-			Dimming is triggered with a long press of the button
		NCC	-			
	Blind sensor	NOC	-			Movement command is triggered with a long press of the button
		NCC	-			
	Staircase light sensor	NOC	-		After time	Setting switch-off delay for actuator parameters
		NCC	-		After time	
	Scene sensor	NOC	-		-	-
		NCC	-		-	
	Force-position sensor	NOC	Force-position On			The actuator is put into the "Activated" or "Deactivated" state and locked against any further operation. After cancelling the forced control, the actuator returns to its original state
		NOC	Force-position Off			
		NCC	Force-position On			
		NCC	Force-position Off			
	Blind force-position	NOC	Force-position top			The blind is put into the "Top" or "Bottom" state and locked against any further operation.
		NOC	Force-position bottom			

		NCC	Force-position top			After cancelling the forced control, the blind returns to its original state
		NCC	Force-position bottom			
	Movement detector sensor	NOC	–		After time	Setting switch-off delay for actuator parameters
		NCC	–		After time	
	Window contact	NOC	–			–
		NCC	–			
	Wind alarm	NOC	–			During a wind-, frost-, or rain alarm the linked blinds retract and are locked against manual operation. After cancelling the alarm the blinds return to their original position
		NCC	–			
	Frost alarm	NOC	–			During a wind-, frost-, or rain alarm the linked blinds retract and are locked against manual operation. After cancelling the alarm the blinds return to their original position
		NCC	–			
	Rain alarm	NOC	–			During a wind-, frost-, or rain alarm the linked blinds retract and are locked against manual operation. After cancelling the alarm the blinds return to their original position
		NCC	–			
	Switchover heating/cooling	NOC	–			Serves for switchover between heating/cooling mode of the RTC. Activation via winter/summer mode. Switchover of heat pumps
		NCC	–			

Table 16: Switching behaviour of binary inputs

- NOC – Normally open contact
- NCC – Normally closed contact
- Activation/deactivation with rising edge
- Activation/deactivation with falling edge
- "Window open" after rising edge
- "Window open" after falling edge
- "Window closed" after falling edge
- "Window closed" after rising edge

5.3 Weather station

The free@home weather station serves for the detection of brightness, temperature, rain and wind speed.

The weather station has three brightness sensors for detecting a value that is as precise as possible, even during different positions of the sun. The rain sensor is heated in order to prevent the formation of dew and rapid drying out after rain.

The weather station is surface-mounted and has a free@home bus connection, as well as a 230 V connection for heating the rain sensor (option).

To be able to move the blinds automatically during rain or a wind alarm, the sensors of the weather station can be firmly linked with the blind actuators. Or they can be used to define dynamic rules (e.g.: "When temperature > 27° and brightness, then move blind to position X") in menu item "Actions" (see Page 41).

The current measured values of the weather station are displayed in menu item "Status" of the user interface.



Fig. 73: Weather station

free@homeWeather station WS-1	
Multifunctional sensor to detect brightness, temperature, rain and wind	
Icon of the user interface	
Operating voltage	110 V - 230 V AC, 50/60 Hz
Brightness sensors	3 x
Brightness measuring range	1 - 100,000 lux
Temperature measuring range	-30°C - +60°C
Rain sensor display	Rain / no rain
Measuring range of wind sensor	2 – 30 m/s
Protection	IP 44 according to EN 60529
Dimensions (L x W x H)	227 mm x 121 mm x 108 mm

Table 17: Weather station WS-1

5.3.1 Allocation

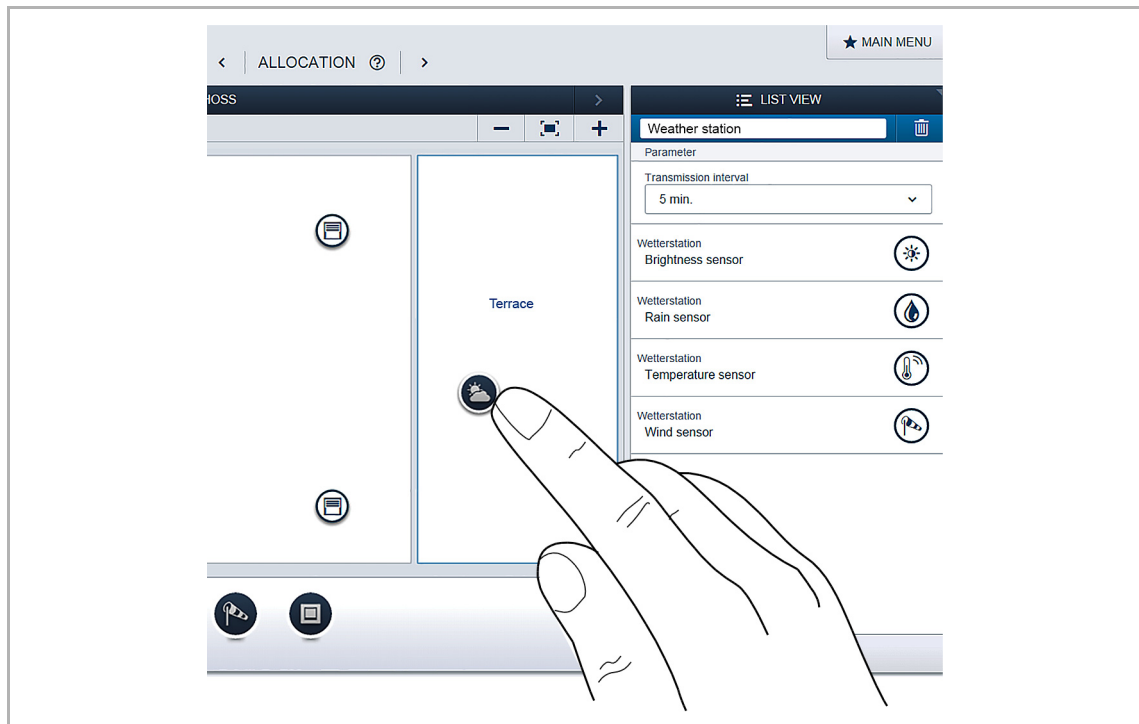

Fig. 74: Allocation of weather station

1. Position the icon of the weather station on the floor plan.
2. To display the parameters of the weather station, click/tap on the weather station icon.

Icon	Description
	Brightness sensor: The range of the brightness threshold value can be set between 1 and 100,000 lux. If the set brightness is exceeded, a shading scene is triggered after 5 minutes. If it falls below the set value, a second scene is triggered after a delay of 15 minutes.
	Rain sensor: At the detection of rain, a rain alarm is triggered. A connected blind is moved in without delay and locked in this position. It can not be moved manually in this state. Also movement commands programmed via a time profile are not carried out. After the sensor has dried, the blind is moved out again to the original position with a delay of 10 minutes. If a movement command has in the meantime been sent from a time profile, the blind is moved to the position programmed in it.
	Temperature sensor: If the temperature drops below the set value, a frost alarm is triggered. A connected blind is moved in with a delay of 5 minutes and locked in this position. It can not be moved manually in this state. Also movement commands programmed via a time profile are not carried out. If the set temperature is exceeded, the blind is moved again to the previous position with a delay of 15 minutes. If a movement command has in the meantime been sent from a time profile, the blind is moved to the position programmed in it.
	Wind sensor: If the wind speed defined here is exceeded, a wind alarm is triggered. A connected blind is moved in without delay and locked in this position. It can not be moved manually in this state. Also movement commands programmed via a time profile are not carried out. If the wind speed drops below the set value, the blind is moved again to the previous position with a delay of 10 minutes. If a movement command has in the meantime been sent from a time profile, the blind is moved to the position programmed in it.

Table 18: Sensor allocation for weather station

5.3.2 Linking sensors of the weather station

The sensors of the weather station can be linked with one or several actuators in the linking menu. The actuators trigger when the values drop below or are exceeded. The brightness sensor can also be linked with two scenes. One scene becomes active when the value is exceeded, the other scene when the value drops below its setting.

The settings are stored directly in the individual bus subscribers and will still function even if the System Access Point breaks down due to a malfunction.

Linking brightness sensors

1. Create a "Shading" scene and link it with all blinds.
2. Move the blind to the position it is to occupy when shading becomes necessary and store the scene.
3. Create a "Blinds top" scene and link it also with all blinds.
3. Move the blinds to the top position and store the scene.
4. Link the brightness sensor with both scenes.

Linking rain sensors

1. Link the rain sensor with all blinds that are to be moved in during a rain alarm.

Linking temperature sensors

1. Link the temperature sensor with all blinds that are to be moved in during a frost alarm.
- The function is used generally with external blinds to prevent the slats from freezing solid.

Linking wind sensors

1. Link the wind sensor with all blinds that are to be moved in during a wind alarm.

5.4 Actuators

5.4.1 Switch actuators

Switch actuators receive the control commands from sensors and then switch their switching contacts. An actuator can be programmed via the user interface either as individual switching contact or with a timer function or a staircase light function.



Fig. 75: Switch actuator and sensor/switch actuator



Article no.	Product name	Construction type	Input channels	Switching channels	Switching load
SA-M-0.4.1	Switch actuator, 4gang	Rail-mounting	0 –	4 	4 x 16 A
SA-M-8.8.1	Sensor/switch actuator, 8/8gang	Rail-mounting	8 	8 	8 x 6 A

Table 19: Switch actuators

Parameter settings

see chapter “Parameter settings of 1/1gang sensor/switch actuator“ on page 57 (only 4gang or 8/8gang possible)

5.4.2 Dimming actuators

Dimming actuators receive the control commands from sensors and then dim their dimming outputs. The dimmer can be programmed via the user interface either as individual switch or with a timer function or a staircase light function.



Fig. 76: Dimming actuator DA-M-0.4.1

Article no.	Product name	Construction type	Input channels	Switching channels	Switching load
DA-M-0.4.1	Dimming actuator, 4gang	Rail-mounting	0 –	4 	4 x 315 W/WA

Table 20: Dimming actuator

Parameter settings

see chapter "Parameter settings of 1/1gang sensor/dimming actuator" on page 59 (only 4gang possible).

Channels can be bundled via the device configuration in the System Access Point (only via user access "Fitter").

Error states (Flash codes of dimming actuator 4gang)

Errors are displayed via different flashing codes of the related green channel LEDs.

Error	Flashing cycle per 5 seconds	Cause
Excess temperature	1 flash	Too many loads are connected to the channel, or the temperature in the dimmer is too high. Derating is activated.
Short-circuit	2 flashes	Short-circuit in the dimming channel
Wire break or missing load	3 flashes	Cable break or defective load
Overvoltage	4 flashes	E.g.: An inductive transformer is being operated in the wrong operating mode (trailing edge control).
Internal protective circuits	5 flashes	Various critical errors that are based on a hardware defect, e.g. a defective output.

Table 21: Error states

5.4.3 Blind actuators

Blind actuators receive the control commands from sensors and then switch their switching outputs.

If the blind actuator is linked with a sensor, the blind can be moved with a long press of the button, and the lamella adjusted with a brief press of the button.



Fig. 77 Blind actuator BA-M-0.4.1

Wind alarm

As soon as a wind sensor is configured in the system (for description of function see chapter 5.2 “Binary inputs“ on page 75), all blind actuators are coupled to its output signal. This means that during a wind alarm all roller blinds/awnings and blinds move to their top end position and are locked. They can then no longer be moved manually via the control elements. A flashing LED on the control element indicates that the blind is locked. All actuators which are not to respond to the wind alarm can be deactivated via the user interface.

Position fixing/calibrating

Aside from the top/bottom end positions, a blind can also move to intermediate positions, e.g. 50% top. The position is fixed on the basis of the movement time of the blind. Since this movement time varies individually, it must be set separately for each blind.

If the blind has not been calibrated, the visualization cannot display an actual position and only the top/bottom end points can be moved to. The movement time can be set in the device settings of the user interface.

The LED of a sensor, which is connected with a non-calibrated blind, flashes at the point of delivery until the calibration has been carried out.

Article no.	Product name	Construction type	Input channels	Switching channels	Switching load
BA-M-0.4.1	Blind actuator 4gang	Rail-mounting	0 –	4 	4 x 6 A

Table 22: Blind actuator

Parameter settings

see chapter “Parameter settings of 1/1gang sensor/blind actuator“ on page 61 (only 4gang possible).

5.4.4 Heating actuators

Heating actuators are suitable for the activation of thermoelectric servo valves. They can only be controlled by the room temperature controller (RTC). Three servo valves share one input voltage terminal. The current via this common terminal must not exceed $I_n = 0.5 \text{ A}$.



Fig. 78: Heating actuators



Article no.	Product name	Construction type	Input channels		Switching channels		Switching load
HA-M-0.6.1	Heating actuator 6gang	Rail-mounting	0	–	6		4 x 16 A
HA-M-0.12.1	Heating actuator 12gang	Rail-mounting	0	–	12		8 x 6 A

Table 23: Heating actuators

Parameter settings

The following settings are possible:

1. Function
 - Valve for heating
 - Valve for cooling
 - Valve for heating and cooling
2. Contact type
 - Opened de-energized
 - Closed de-energized
3. Specifying the valve opening in % during faults.

5.5 System Access Point

The System Access Point establishes the connection between the free@home participants and the smartphone, tablet or PC.

It is used to identify and program the participants during commissioning. It also executes time and astro programs and serves as exchange to switch functions via the free@home app.

5.5.1 Identification

Devices which are physically connected to the free@home bus, log themselves automatically into the System Access Point. They share information about their type and supported functions.

During initial commissioning all devices are given a universal name (Sensor/switch actuator 1/1gang, etc.). The installer must change this name within the commissioning process to a name practical and specific for the system (in case of an actuator, e.g. in "Living room ceiling light").



Fig. 79: Identification

5.5.2 Identification of wireless devices

When energized, a device that has not been programmed is in programming mode for 30 minutes and can be logged into the system. Programmed devices share information about their type and supported functions with the System Access Point.

During initial commissioning all devices are given a universal name (Sensor/switch actuator 1/1gang, etc.). The installer must change this name within the commissioning process to a name practical and specific for the system (in case of an actuator, e.g. in "Living room ceiling light").

5.5.3 Network functions

Access point mode

The access point mode is intended for commissioning of the system. The System Access Point establishes its own WLAN and acts as DHCP server (devices which connect themselves as client with the WLAN receive an IP address automatically).

Advantage: The system can be made operational and operated without a router (e.g. FRITZ!Box).

Disadvantage: In access point mode the System Access Point cannot be simultaneously connected to an Internet router. For continuous operation the System Access Point should therefore be configured as LAN or WLAN client. This allows the users to both surf on the Internet with their devices and operate the free@home system without having to change between different WLAN networks.

To activate or deactivate the access point mode:

1. Press the access point button.

During initial commissioning the access point mode is automatically activated.

The network name (SSID), the WLAN password and the IP address of the System Access Point are located on a label in the interior of the device (power adaptor).

LAN/WLAN client mode

If a router is already available it is recommended to connect the System Access Point with this network via LAN or WLAN as client.

The following three options are available to activate the client mode:

- A: Connect the System Access Point via LAN with the router before commissioning.
- When the cable is plugged in, it is recognized automatically and the access point mode is deactivated.
 - The System Access Point receives an IP address from the router automatically.
 - During the attempt to connect, the connection display flashes.
 - After the connection has been successfully established the connection display lights up permanently.
- B: Connect the System Access Point via LAN with the router after commissioning.
- For this connection the access point mode must be deactivated manually. This can be carried out with a press of the button on the device itself or in the network settings of the user interface.
 - The System Access Point receives an IP address from the router automatically.
 - During the attempt to connect, the connection display flashes.
 - After the connection has been successfully established the connection display lights up permanently.
- C: Connect the System Access Point via WLAN with the router after commissioning.
- This connection must be carried out via the network settings of the user interface. There select the name of the network with which you want to connect the System Access Point and enter the network key.



NOTE

The list of recommended network names (SSIDs) is created during the boot-up process of the System Access Point. The WLAN networks that cannot be reached at this point will not be shown in the list of recommendations.

- The System Access Point receives an IP address from the router automatically.
- During the attempt to connect, the connection display flashes.
- After the connection has been successfully established the connection display lights up permanently.

The access point mode can be activated again at any time. If the access point mode is deactivated, the LAN client or (if it has been configured) the WLAN client mode is activated.

5.5.4 Control and display elements



Access point button	Connection display	Status indication
		
Button function: Button operation switches the access point mode on/off	Button function: None	Button function: None
LED status: On: Access point mode on Off: Access point mode off	LED status: On: Connection with LAN/WLAN Off: No connection with LAN/WLAN Flashing: Connection try	LED status: Green (short): Voltage supplied Yellow: Device is booting Green (constantly): Device is ready for operation Off: No voltage Flashing: Fault

Table 24: System Access Point control and display elements

5.5.5 Master reset without access to the Web interface

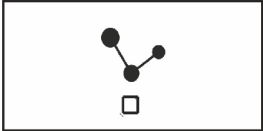

NOTE

At a master reset, without access to the web interface of the System Access Point, all user data, floor plans and time programs will be permanently deleted.

To perform a master reset:

1. Lift the cover off the System Access Point.
 2. Briefly press the reset button (above the bus connection terminal).
 3. While the boot-up process starts, simultaneously press the access point button, the "Connection display" button and the "Status indication" button until all three button LEDs light up. This can take up to a minute.
- The System Access Point is then back to its factory settings.

5.5.6 Additional general settings in the System Access Point

System information

Current software version status.

Network

The network settings of the System Access Point can be programmed in menu "Network".

Possible settings:

- LAN client: Used when the System Access Point is connected to the Internet router via network cable.



NOTE

This mode is activated automatically when the access point mode is deactivated (LED of the left button is off).

- WLAN client: Used when the System Access Point is connected to the Internet router via WLAN.

Users

In the "User" menu additional users can be created or users deleted.

Localization

Setting of the system name, the system language, the location and the time.

Data backup

The data backup stores all the settings made. The backup is first carried out on the internal memory of the System Access Point. But it can also be exported.

A data backup is created automatically at regular intervals. But it can also be created manually.

Data backups that have been created by user type "Fitter", can be restored by other users. But they cannot be deleted by them.

Update

Firmware update of the System Access Point and the free@home devices.

The update file contains both the updates of the System Access Point as well as the updates for all system devices.

The update consists of four steps:

1. Upload the firmware to the System Access Point.
 - Takes place automatically after selection of the update file.
2. Processing the firmware.
 - Takes place automatically after the successful update. The process can take a few minutes.

3. Installation of the firmware.
 - Takes place after confirming the update dialogue. The update takes a few minutes.
 - After the update has been carried out successfully, the System Access Point restarts. This could lead to the website in the Internet browser continuing to indicate an ongoing update process, even though it has already been completed. An update of the website (F5 key) rectifies the problem.
4. Firmware update of all free@home devices connected to the bus.
 - After confirming the update dialogue, all free@home devices connected to the bus are updated automatically. The update is always carried out simultaneously on two devices and can be recognized by the mutual flashing of the LEDs. The process takes approximately two minutes for each device. The system can be operated as usual during the update.

Service

- **Updating all devices:** Loads the current firmware to the free@home devices. This process is only necessary when the update of the devices was rejected during the update dialogue.
- **Master reset:** Resets all free@home devices connected to the bus to the factory settings. All data backups, user data, floor plans and time programs are retained.
- **Resetting the database:** Resets the System Access Point completely or partly to the factory settings. The selection of the parameters to be reset is made in the pop-up window.

6 Device Functions

Icon	Information	
	Name:	Sensor
	Type:	Sensor
	Made available by:	Sensor unit, sensor/switch actuator, sensor/dimming actuator, sensor/blind actuator
	Function:	Control element for the control of free@home functions
	Name:	Movement detector
	Type:	Sensor
	Made available by:	Movement detector, movement detector/switch actuator
	Function:	Sensor for movement- and brightness-dependent control of free@home functions
	Name:	Room temperature controller (RTC)
	Type:	Sensor
	Made available by:	Room temperature controller
	Function:	Controls free@home heating actuators
	Name:	Panel
	Type:	Sensor
	Made available by:	free@homeTouch 7" and 4.3"
	Function:	The location for installation and name of the panel can be changed
	Name:	switch actuator
	Type:	Actuator
	Made available by:	Switch actuator, sensor/switch actuator, movement detector/switch actuator
	Function:	Switches connected loads
	Name:	Dimming actuator
	Type:	Actuator
	Made available by:	Dimming actuator, sensor/dimming actuator
	Function:	Dims connected loads
	Name:	Blind Actuator
	Type:	Actuator
	Made available by:	Blind actuator, sensor/blind actuator
	Function:	Moves connected blinds and roller blinds
	Name:	Heating actuator
	Type:	Actuator
	Made available by:	Heating actuator, sensor/blind actuator
	Function:	Controls heating actuators

Icon	Information	
	Name:	Wind alarm
	Type:	Sensor
	Made available by:	Binary input
	Function:	Triggers a wind alarm
	Application:	Automatic retraction of the blinds
	Name:	Window contact
	Type:	Sensor
	Made available by:	Binary input
	Function:	Signals "Window open"
	Name:	Rain alarm
	Type:	Sensor
	Made available by:	Binary input
	Function:	Triggers a rain alarm
	Name:	Frost alarm
	Type:	Sensor
	Made available by:	Binary input
	Function:	Triggers a frost alarm
	Name:	Switchover heating/cooling
	Type:	Sensor
	Made available by:	Binary input
	Function:	Switches the room temperature controller over between heating mode and cooling mode.
	Name:	Floor call
	Type:	Sensor
	Made available by:	free@homeTouch 7"
	Function:	Signals an incoming floor call
	Name:	Floor call button
	Type:	Actuator
	Made available by:	free@homeTouch 7"
	Function:	Triggers a floor call
	Application:	A free@home sensor is used as floor call button





Icon	Information	
	Name:	Door opener
	Type:	Actuator
	Made available by:	free@homeTouch 7"
	Function:	Actuates the door opener of the ABB-Welcome® system
	Application:	A free@home sensor is to actuate the door opener
	Name:	Door call
	Type:	Sensor
	Made available by:	free@homeTouch 7"
	Function:	Signals an incoming door call
	Name:	Automatic door opener
	Type:	Actuator
	Made available by:	free@homeTouch 7"
	Function:	Activates/deactivates the automatic door opener
	Name:	Corridor light
	Type:	Actuator
	Made available by:	free@homeTouch 7"
	Function:	Switches the corridor switch contact of the ABB-Welcome® system controller
	Name:	Weather station
	Type:	Sensor
	Made available by:	Weather station
	Function:	Makes available a wind sensor, temperature sensor, brightness sensor and rain sensor.
	Application:	Used in "Actions" or as weather alarms. Linked with blind actuators

Table 25: Overview of device functions

7 Functional system extensions

7.1 Phillips Hue

7.1.1 Philips Hue integration

The integration of the Philips Hue system into free@home is carried out with the aid of the Philips Hue API. This means that the commands of the free@home system are "compiled" within the free@home System Access Point, and transmitted from there via the IP protocol to the Philips Hue Bridge. The Philips Hue Bridge then controls the lamps via the Zigbee protocol.

Prerequisite for the integration of the Philips Hue system into free@home is:

- a router [1]
- an operable Philips Hue system [2]
- an operable free@home system [3]

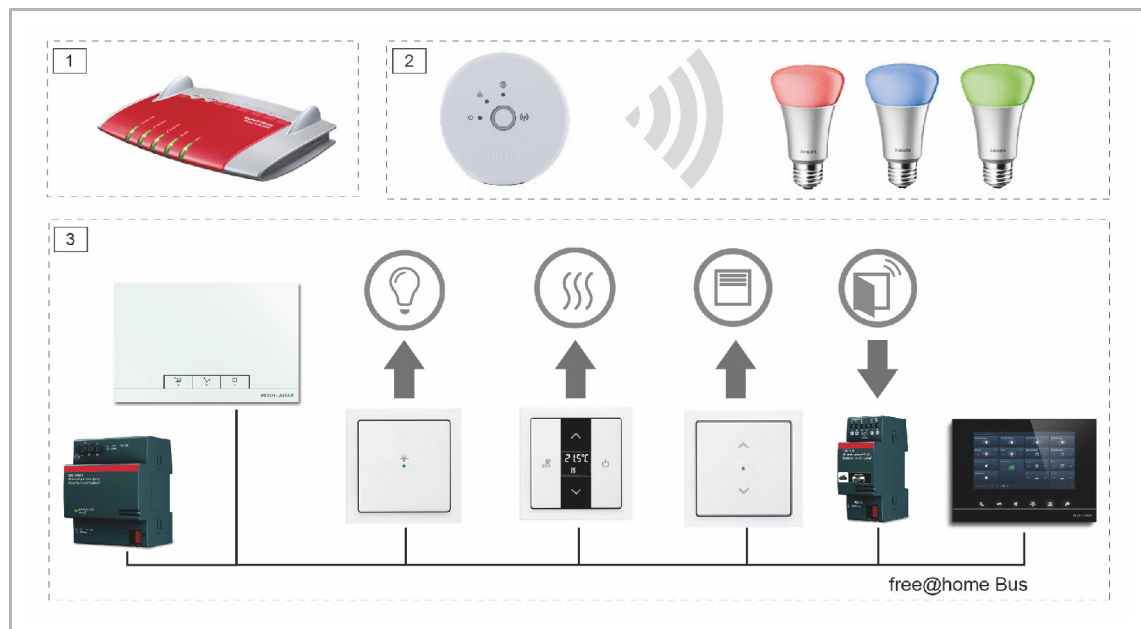

Fig. 80: Philips Hue Integration

7.1.2 Phillips Hue setup

Preparatory work: Commissioning of the free@home system and commissioning of the Philips Hue system. Both systems must be located in the same network.

1. Carry out a firmware update of the free@home System Access Point to Version 1.2 or higher (via an automatic update or a manual update).
2. Open the free@home user interface and log yourself in as "Fitter".
 - A pop-up window appears "NEW HUE BRIDGE DETECTED".

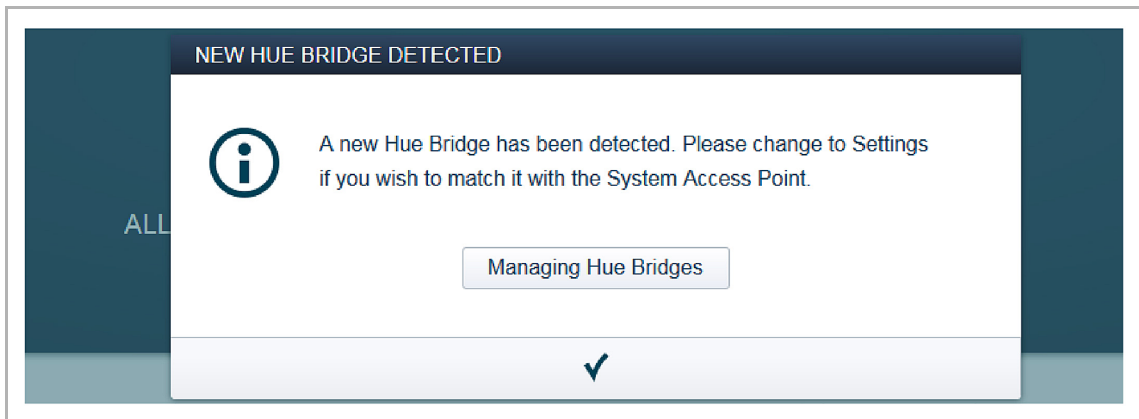

Fig. 81: Hue Bridge pop-up window

3. Click/tap on "Managing Hue Bridges" in the pop-up window.
 - The management of "Hue Bridges" appears in the "Settings". Here several Philips HUE bridges of a free@home system can be managed.

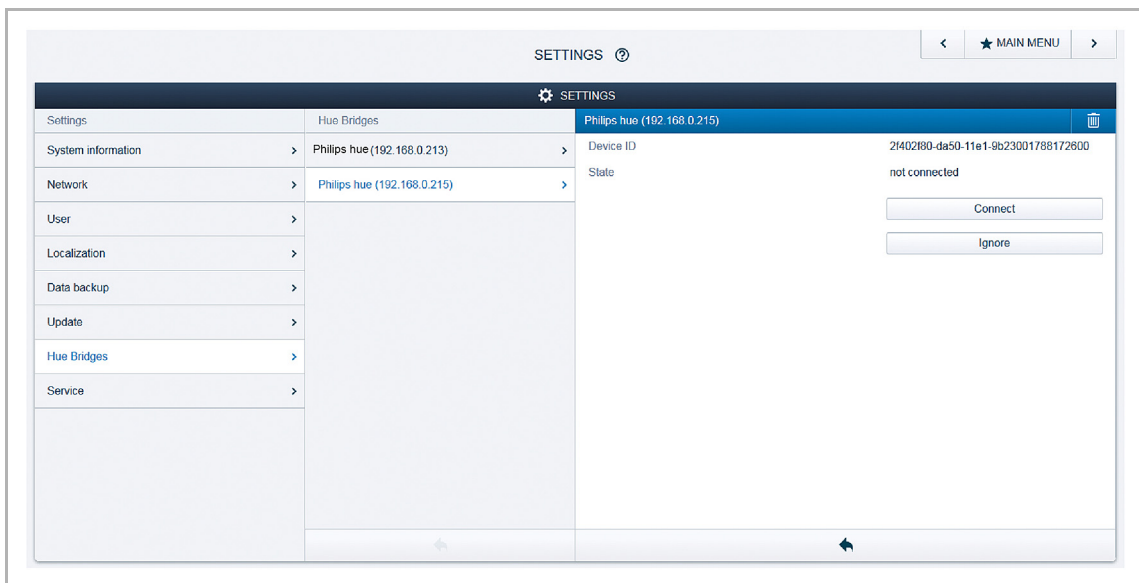

Fig. 82: Philips Hue settings



Fig. 83: Philips Hue identification

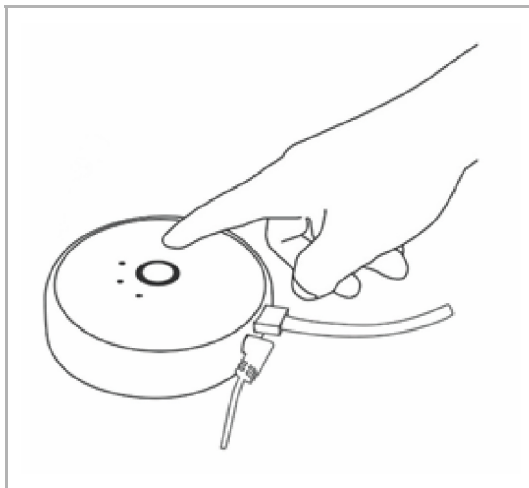

Fig. 84: Confirmation of the Philips Hue Bridge

If several Philips Hue Bridges are to be available in the network, the Bridge required can be identified by means of your MAC address. This can be read on the Hue Bridge or in the Hue app ("Settings -> My Bridge").

If there is a HUE Bridge available in the network which is not to be managed via free@home, it can be set on "Ignore". This prevents the pop-up window "NEW HUE BRIDGE DETECTED" for the located HUE Bridge to be displayed during each additional a login.

4. Select the desired Bridge and click/tap on "Connect".
5. To confirm the connection, press the push-button on the Hue bridge.
 - This completes the Philips Hue setup.

7.1.3 Allocating links

For all additional steps the Philips Hue lamps behave as already known from the free@home actuators:

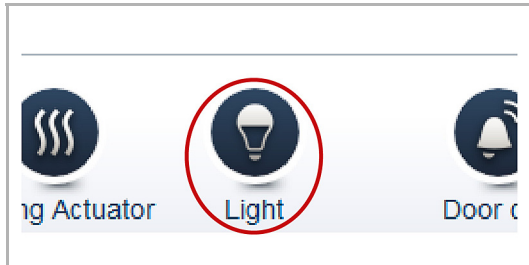

Fig. 85: Philips Hue icon

The Philips Hue lamps appear in the "Allocation" area under their own icon.

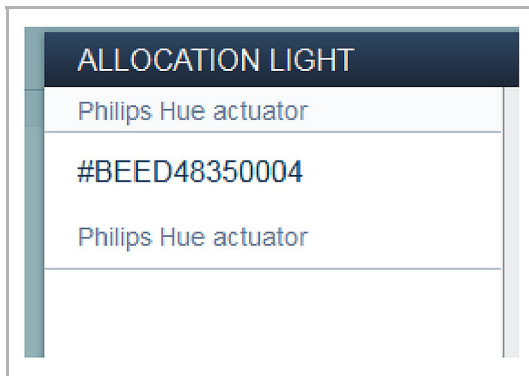

Fig. 86: Philips Hue selection window

1. Position the lamp icon on the floor plan.
 - A selection window appears with all Philips Hue lamps connected to the bridge.
 - The names of the lamps that were previously assigned during the setup are displayed.

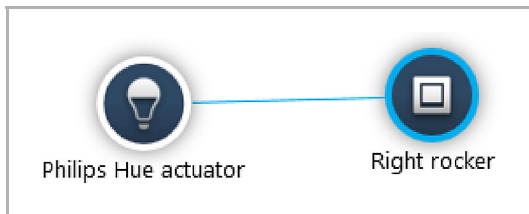

Fig. 87: Philips Hue connection

2. Select a Phillips Hue lamp in the selection window.
 - The lamp appears on the floor plan.
3. Connect the lamp with a sensor, or integrate it into a scene.
 - The Phillips Hue lamp behaves like a dimmer:
A brief press of the button switches the lamp on or off. A long press of the button dims the lamp brighter or darker.

7.1.4 Parameters

The Philips Hue lamps basically have the same parameters as a dimmer, with the exception of switch-on modes, see chapter “Parameter settings of 1/1gang sensor/dimming actuator“ on page 59.

7.1.5 Colour settings

If the Philips Hue lamp is connected with only one free@home sensor, no specific setting of a colour is then possible. The lamp can be switched on/off and dimmed, or switched on with the previously set colour.

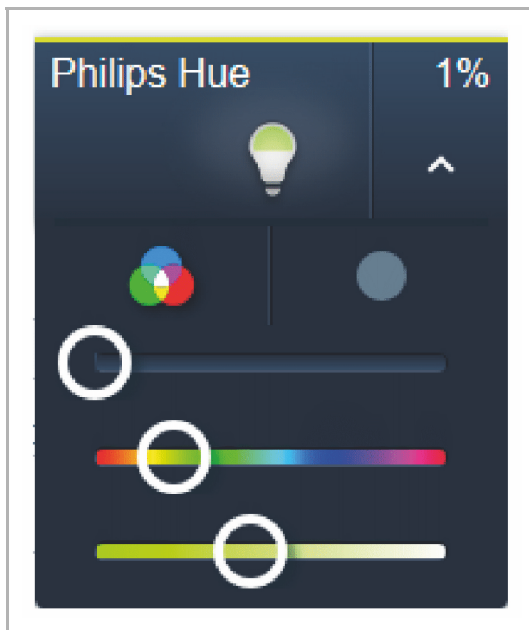

Fig. 88: Philips Hue colour settings

The specific colour of the lamp can be set via the free@home user interface (both via the configuration interface, as well as the control interface), the app, or via the free@home panel (from firmware version 1.1).

If a specific colour is to be set via a sensor:

1. Link the Philips Hue lamp with a scene.
2. Set the desired colour in this scene.
3. Link the scene with the sensor.

7.1.6 Time control

Similar to all actuators, the Philips Hue lamp can also be controlled via the timer. Aside from the brightness, also a colour value can be selected here. By creating several switching times, for example, a sunrise or sundown can be simulated.

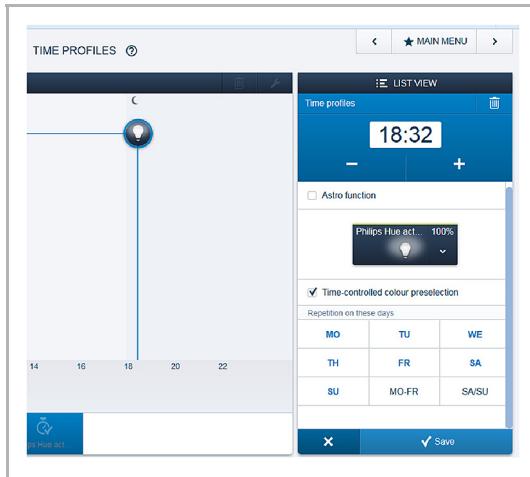

Fig. 89: Philips Hue time profiles

In the "Timing" area the "Time-controlled colour preselection" parameter can be selected for the Philips Hue lamp.

If the parameter is set, the colour with which the lamp is switched on at the next switch-on command is pre-selected at the set time. This, for example, allows you to specify that the bedroom lamp switches on in the morning with cold white and in the evening with a dimmed warm white.

7.1.7 Philips Hue parameter settings

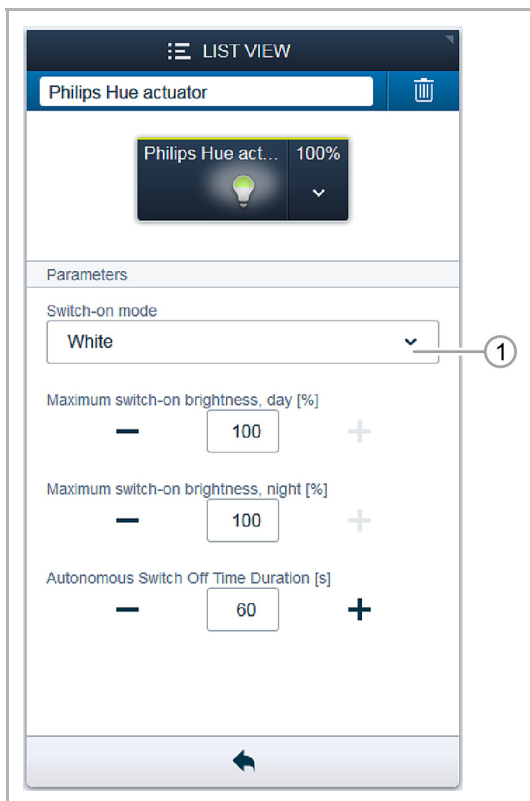

Fig. 90: Actuator settings of Philips Hue lamp

[1] Switch-on mode

- "White": The lamp switches on with 100% brightness white.
- "White with the previous brightness": The lamp switches on with the previous brightness.
- "Previous colour": The lamp switches on with the previous brightness and the previously set colour.

Example: The colour is set via the Philips Hue app and then switched off. At the next activation via free@home, the lamp switches on again with the previous colour.

8 Overview of Product Range

8.1 System devices

Power supply

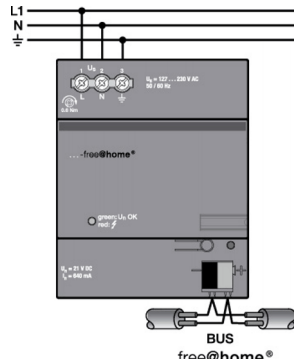
	Device	Connection
	 <p data-bbox="638 913 782 969">PS-M-64.1.1 640 mA</p>	

No separate power supply is required for pure wireless systems.

System Access Point

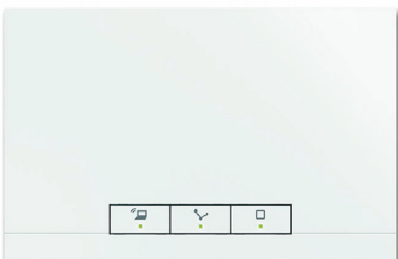
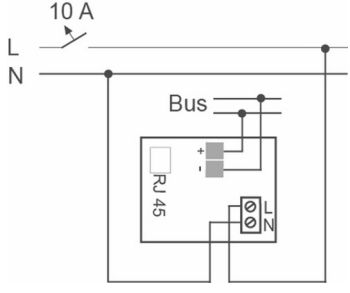
	Device	Connection
	 <p data-bbox="638 1579 782 1635">SAP-S-2 SAP-S-127.2</p>	

8.2 Displays

free@homeTouch 7"



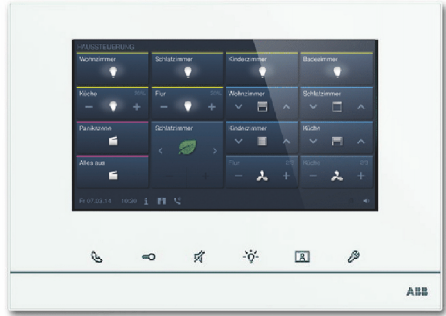

DP7-S-6xx
16 free@home-functions
ABB-Welcome®

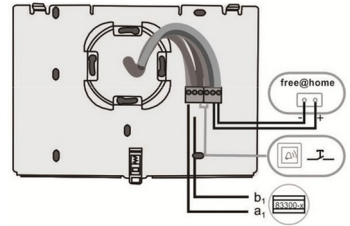

8.3 Sensors

Sensor units

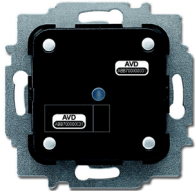
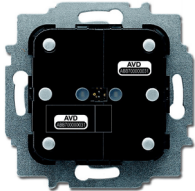
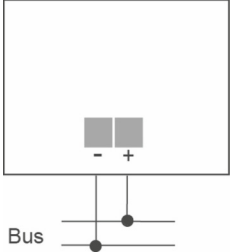
Icon	1gang	2gang	Connection
	 SU-F-1.0.1	 SU-F-2.0.1	 Bus

Sensor units wireless

Icon	1gang	2gang	Connection
	 SU-F-1.0.1-WL	 SU-F-2.0.1-WL	 10 A L N

Movement detector

Icon	1gang	Connection
	 MD-F-1.0.1...	 Bus



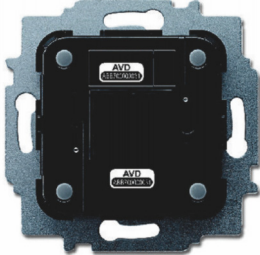
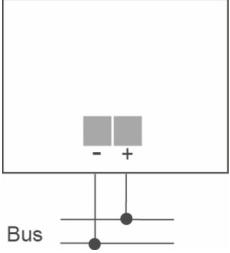

Room temperature controller

Icon	1gang	Connection
	 <p data-bbox="663 667 754 696">RTC-F-1</p>	

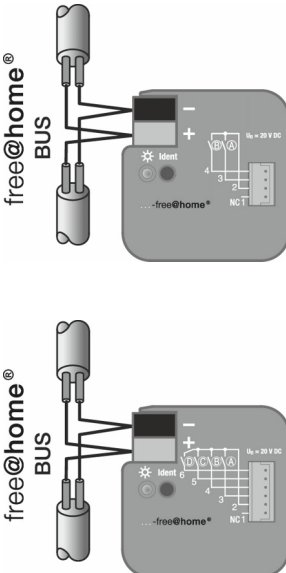

Room temperature controller wireless

Icon	1gang	Connection
	 <p data-bbox="643 1211 775 1240">RTC-F-1-WL</p>	

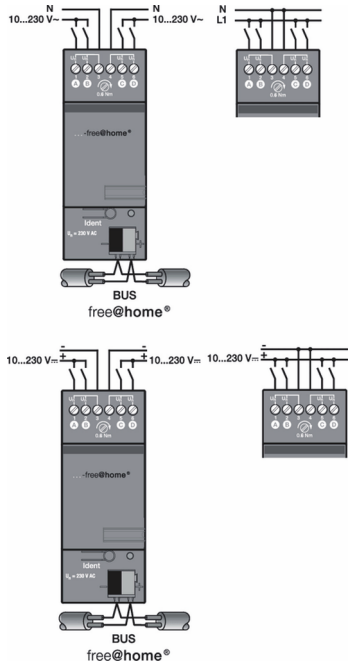
Binary inputs

Icon	2gang	4gang	Connection
	 <p data-bbox="470 862 662 929">BI-F-2.0.1 20 V DC, 0.5 mA</p>	 <p data-bbox="766 862 957 929">BI-F-4.0.1 20 V DC, 0.5 mA</p>	
	<p data-bbox="550 1164 566 1187">-</p>	 <p data-bbox="726 1489 997 1556">BI-M-4.0.1 10 - 230 V AC/DC, 1 mA</p>	

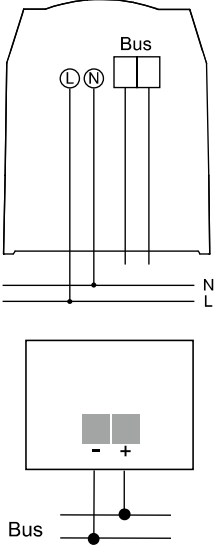

Weather station

Icon		Connection
	 <p data-bbox="517 779 906 875" style="text-align: center;"> WS-1 110 - 230 V AC Brightness, wind, rain, temperature </p>	

8.4 Sensor/actuator units

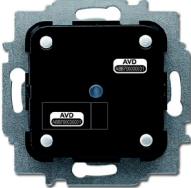
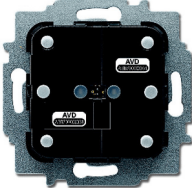
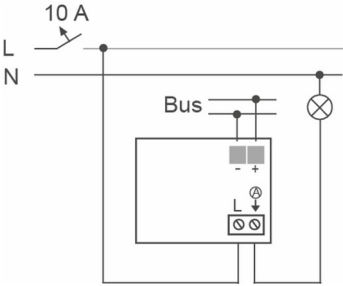
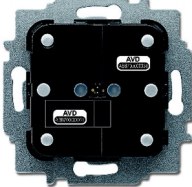
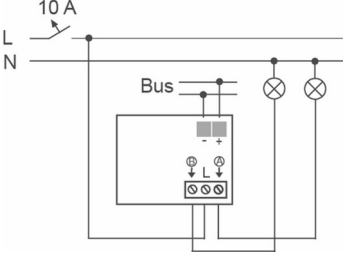
Sensor/switch actuator

Icon	1gang sensor	2gang sensor	Connection
	<p data-bbox="432 1294 459 1458" style="writing-mode: vertical-rl; transform: rotate(180deg);">1gang actuator</p>  <p data-bbox="539 1480 676 1541" style="text-align: center;"> SSA-F-1.1.1 1 x 2300 W </p>	 <p data-bbox="805 1480 943 1541" style="text-align: center;"> SSA-F-2.1.1 1 x 2300 W </p>	
	<p data-bbox="432 1637 459 1800" style="writing-mode: vertical-rl; transform: rotate(180deg);">2gang actuator</p> <p data-bbox="596 1675 608 1691" style="text-align: center;">-</p>	 <p data-bbox="805 1823 943 1883" style="text-align: center;"> SSA-F-2.2.1 2 x 1200 W </p>	

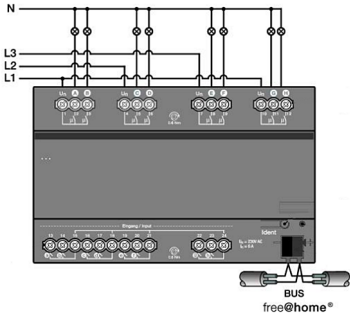
Icon	8gang sensor		Connection
	8gang actuator	 <p style="text-align: center;">SA-M-8.8.1 8 x 6 A, 8 x 32 V DC, 0.1 mA</p>	

Sensor/switch actuator wireless

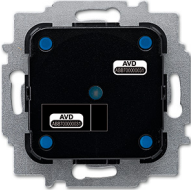
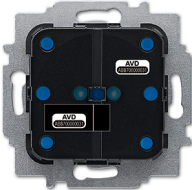
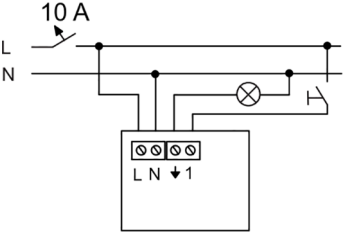
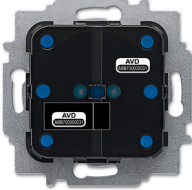
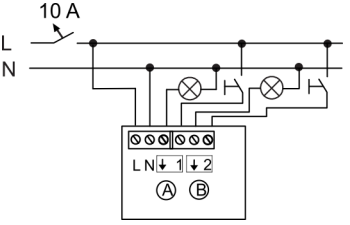
Icon	1gang sensor	2gang sensor	Connection
	 <p style="text-align: center;">SSA-F-1.1.1-WL 1 x 2300 W</p>	 <p style="text-align: center;">SSA-F-2.1.1-WL 1 x 2300 W</p>	
	-	 <p style="text-align: center;">SSA-F-2.2.1-WL 2 x 1200 W</p>	

Ssensor/dimming actuator

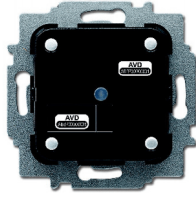
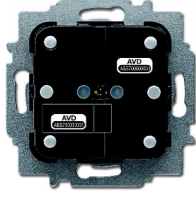
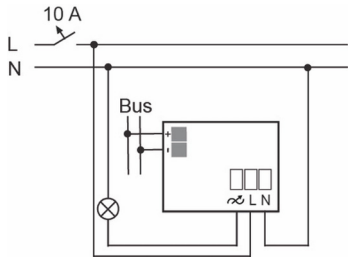
Icon	1gang sensor	2gang sensor	Connection
	<p>1gang actuator</p>  <p>SDA-F-1.1.1 1 x 180 W/VA</p>	 <p>SDA-F-2.1.1 1 x 180 W/VA</p>	

Sensor/dimming actuator wireless

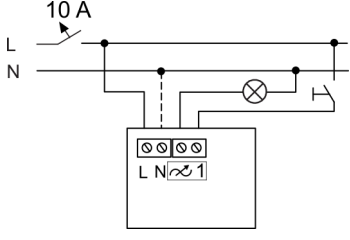
Icon	1gang sensor	2gang sensor	Connection
	<p>1gang actuator</p>  <p>SDA-F-1.1.1-WL 1 x 180 W/VA</p>	 <p>SDA-F-2.1.1-WL 1 x 180 W/VA</p>	

Sensor/blind actuator

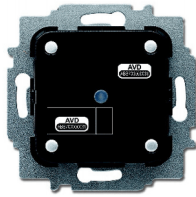
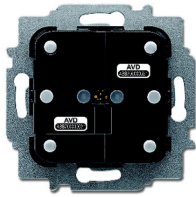
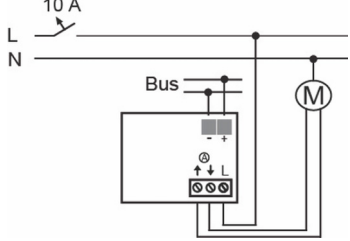
Icon	1gang sensor	2gang sensor	Connection
	<p>1gang actuator</p>  <p>SBA-F-1.1.1 4 A, $\cos \phi = 0.5$</p>	 <p>SBA-F-2.1.1 4 A, $\cos \phi = 0.5$</p>	

Sensor/blind actuator wireless

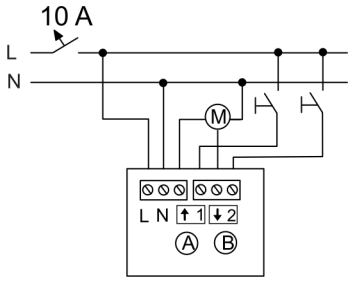
Icon	1gang sensor	2gang sensor	Connection
	<p>1gang actuator</p>  <p>SBA-F-1.1.1-WL 4 A, $\cos \varphi = 0.5$</p>	 <p>SBA-F-2.1.1-WL 4 A, $\cos \varphi = 0.5$</p>	

Movement detector/switch actuator

Icon	1gang sensor	Connection
	<p>1gang actuator</p>  <p>MSA-F-1.1.1-... 1 x 2300 W</p>	

Movement detector/switch actuator wireless



Icon	1gang sensor	Connection
	<p>1gang actuator</p>  <p>MSA-F-1.1.1-...-WL 1 x 2300 W</p>	

Room temperature controller/switch actuator wireless



Icon	1gang	Connection
	 <p data-bbox="619 667 801 696">RTC-F-2.1-1-WL</p>	

8.5 Actuators

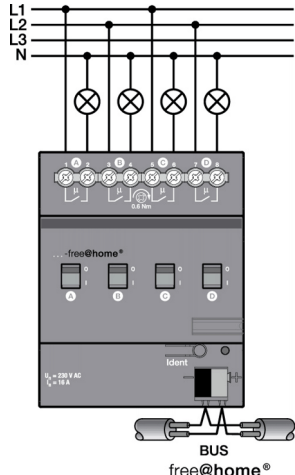

Switch actuators

Icon	4gang	Connection
	 <p data-bbox="651 1361 769 1429">SA-M-0.4.1 4 x 16 A</p>	

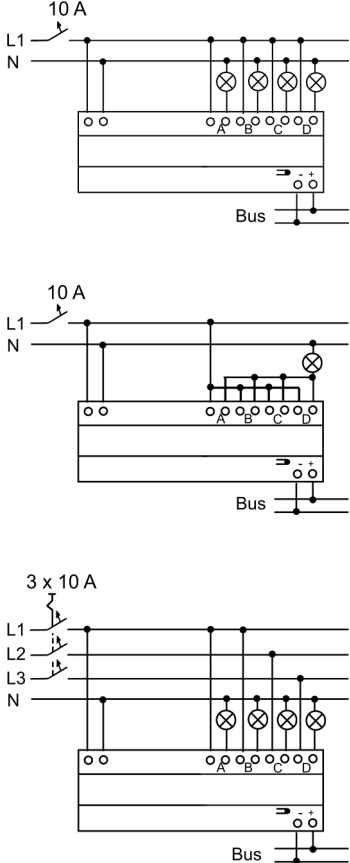

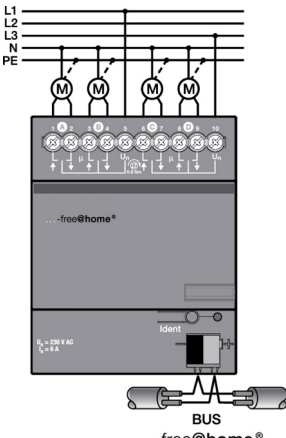

Dimming actuators

Icon	4gang	Connection
	 <p data-bbox="635 965 788 1025">DA-M-0.4.1 4 x 315 W/VA</p>	

Blind actuators

Icon	4gang	Connection
	 <p data-bbox="646 1839 774 1899">BA-M-0.4.1 4 x 6 A</p>	

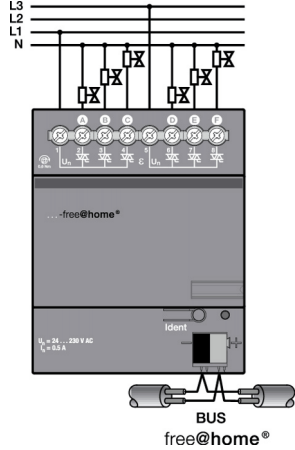
Heating actuators

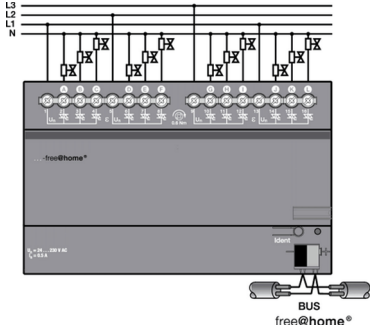
Icon	6gang	Connection
	 <p data-bbox="647 775 772 801">HA-M-0.6.1</p>	
Icon	12gang	Connection
	 <p data-bbox="639 1285 778 1312">HA-M-0.12.1</p>	

8.6 Covers for switch ranges

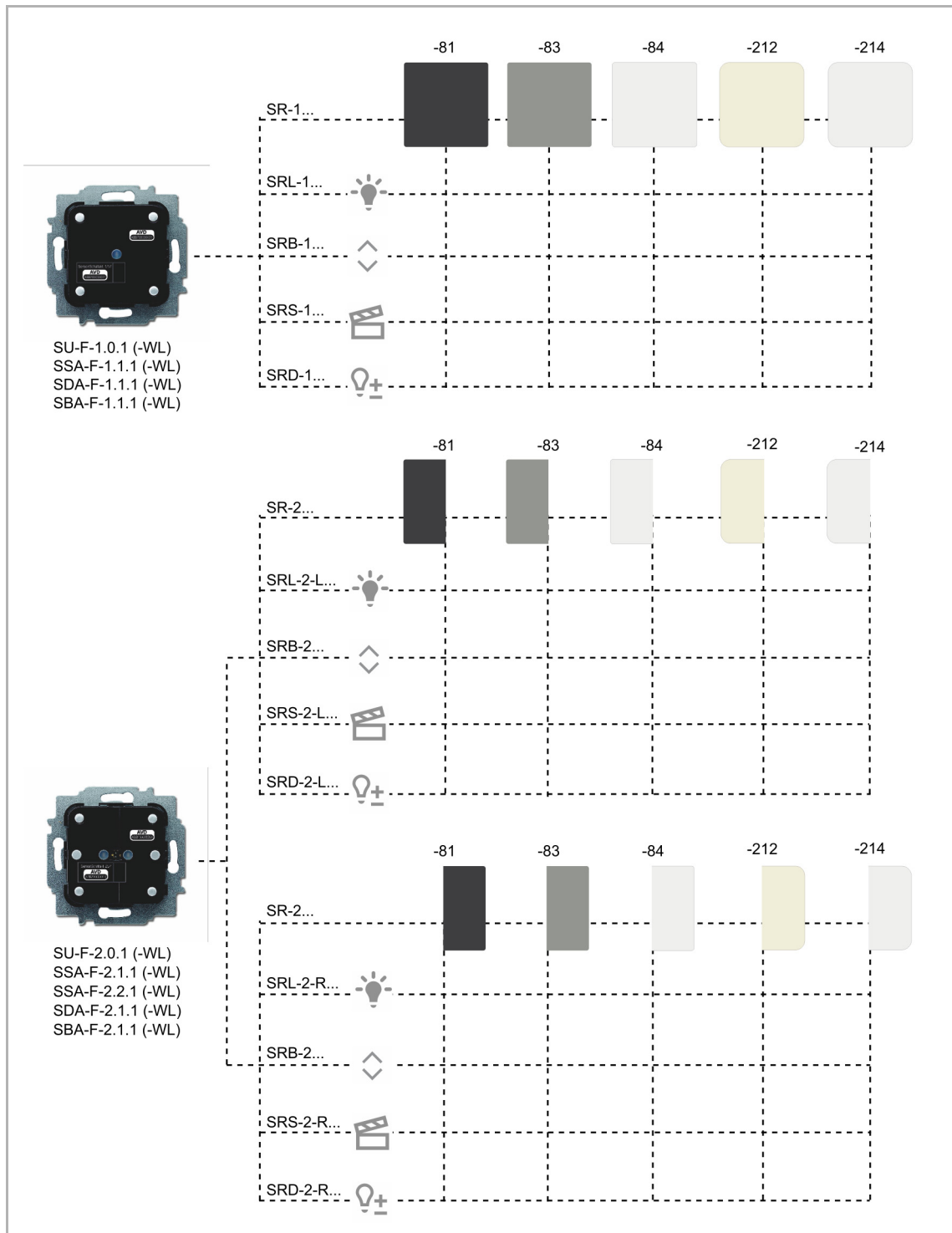

NOTE

Please see the electronic catalogue for all possible switch ranges (www.busch-jaeger-catalogue.com).

8.7 Directory of available covers

Article no.	Printing	Model	Orientation	Program	Colour
SR-1-81	–	1gang	–	future® linear	Anthracite
SR-1-83				solo®	Aluminium silver
SR-1-84				carat® Busch-axcent®	Studio white
SRL-1-81	Light	1gang	–	future® linear	Anthracite
SRL-1-83				solo®	Aluminium silver
SRL-1-84				carat® Busch-axcent®	Studio white
SRB-1-81	Blind	1gang	–	future® linear	Anthracite
SRB-1-83				solo®	Aluminium silver
SRB-1-84				carat® Busch-axcent®	Studio white
SRS-1-81	Scene	1gang	–	future® linear	Anthracite
SRS-1-83				solo®	Aluminium silver
SRS-1-84				carat® Busch-axcent®	Studio white
SRD-1-81	Dimmer	1gang	–	future® linear	Anthracite
SRD-1-83				solo®	Aluminium silver
SRD-1-84				carat® Busch-axcent®	Studio white
SR-2-81	–	2gang	–	future® linear	Anthracite
SR-2-83				solo®	Aluminium silver
SR-2-84				carat® Busch-axcent®	Studio white
SRL-2-L-81	Light	2gang	Left	future® linear	Anthracite
SRL-2-L-83				solo®	Aluminium silver
SRL-2-L-84				carat® Busch-axcent®	Studio white
SRB-2-81	Blind	2gang	–	future® linear	Anthracite
SRB-2-83				solo®	Aluminium silver
SRB-2-84				carat® Busch-axcent®	Studio white
SRS-2-L-81	Scene	2gang	Left	future® linear	Anthracite
SRS-2-L-83				solo®	Aluminium silver
SRS-2-L-84				carat® Busch-axcent®	Studio white
SRD-2-L-81	Dimmer	2gang	Left	future® linear	Anthracite
SRD-2-L-83				solo®	Aluminium silver
SRD-2-L-84				carat® Busch-axcent®	Studio white
SRL-2-R-81	Light	2gang	Right	future® linear	Anthracite
SRL-2-R-83				solo®	Aluminium silver
SRL-2-R-84				carat® Busch-axcent®	Studio white
SRS-2-R-81	Scene	2gang	Right	future® linear	Anthracite
SRS-2-R-83				solo®	Aluminium silver
SRS-2-R-84				carat® Busch-axcent®	Studio white
SRD-2-R-81	Dimmer	2gang	Right	future® linear	Anthracite
SRD-2-R-83				solo®	Aluminium silver
SRD-2-R-84				carat® Busch-axcent®	Studio white

SR-1-212	–	1gang	–	Busch-Duro 2000® SI	White
SR-1-214				Reflex SI	Alpine white
SRL-1-212	Light	1gang	–	Busch-Duro 2000® SI	White
SRL-1-214				Reflex SI	Alpine white
SRB-1-212	Blind	1gang	–	Busch-Duro 2000® SI	White
SRB-1-214				Reflex SI	Alpine white
SRS-1-212	Scene	1gang	–	Busch-Duro 2000® SI	White
SRS-1-214				Reflex SI	Alpine white
SRD-1-212	Dimmer	1gang	–	Busch-Duro 2000® SI	White
SRD-1-214				Reflex SI	Alpine white
SR-2-212	–	2gang	–	Busch-Duro 2000® SI	White
SR-2-214				Reflex SI	Alpine white
SRL-2-L-212	Light	2gang	Left	Busch-Duro 2000® SI	White
SRL-2-L-214				Reflex SI	Alpine white
SRB-2-212	Blind	2gang	Left	Busch-Duro 2000® SI	White
SRB-2-214				Reflex SI	Alpine white
SRS-2-L-212	Scene	2gang	Left	Busch-Duro 2000® SI	White
SRS-2-L-214				Reflex SI	Alpine white
SRD-2-L-212	Dimmer	2gang	Left	Busch-Duro 2000® SI	White
SRD-2-L-214				Reflex SI	Alpine white
SRL-2-R-212	Light	2gang	Right	Busch-Duro 2000® SI	White
SRL-2-R-214				Reflex SI	Alpine white
SRS-2-R-212	Scene	2gang	Right	Busch-Duro 2000® SI	White
SRS-2-R-214				Reflex SI	Alpine white
SRD-2-R-212	Dimmer	2gang	Right	Busch-Duro 2000® SI	White
SRD-2-R-214				Reflex SI	Alpine white
CP-RTC-81	RTC	–	–	future® linear solo® carat® Busch-axcent®	Anthracite
CP-RTC-83					Aluminium silver
CP-RTC-84					Studio white
CP-RTC-212				Busch-Duro 2000® SI	White
CP-RTC-214				Reflex SI	Alpine white

Table 26: Available covers



NOTE

Please see the electronic catalogue for all possible switch ranges (www.busch-jaeger-catalogue.com).

9 FAQ and Tips

9.1 Mounting the System Access Point

The System Access Point is installed surface-mounted. The bus line is always inserted on the rear side. The 230 V power cord and the optional CAT wire can also be inserted on the rear side or installed surface-mounted. In case of surface-mounting, the wires are inserted from the underside of the device via the available breakout openings.

If the CAT wire is inserted on the rear side, it should be ensured that the distance between centres of the two installation boxes amounts to 80 mm.

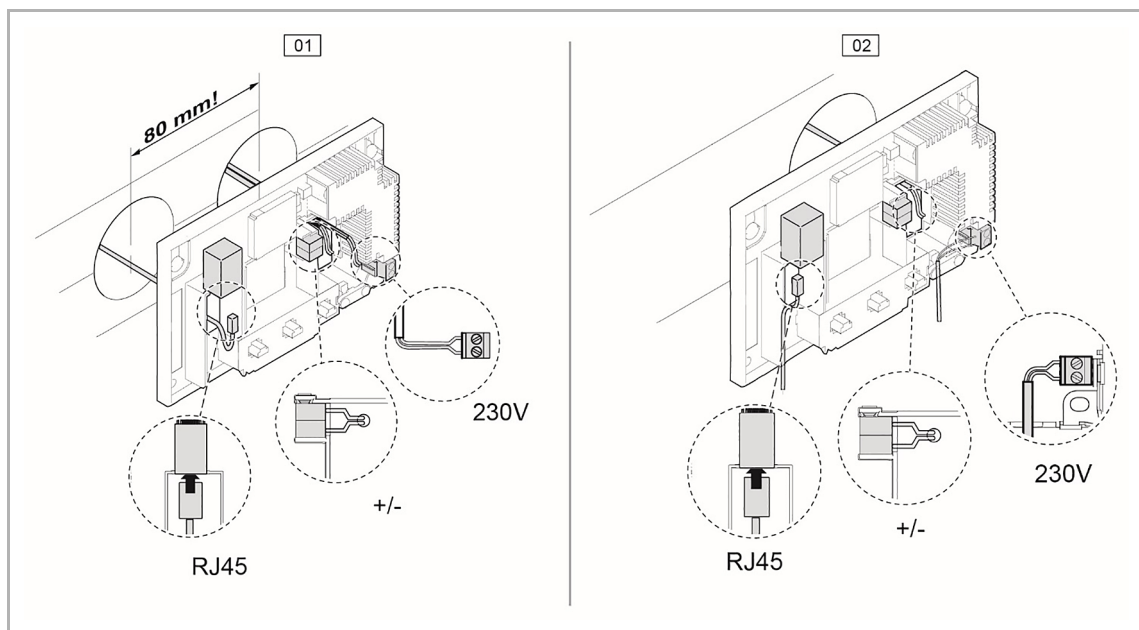

Fig. 91: Mounting the System Access Point

01 – CAT wire inserted on the rear side

02 – CAT wire installed surface-mounted

9.1.1 Connection of the CAT wire

CAT wires that are already patched can be connected directly via the RJ-45 female connector of the System Access Point.

If a CAT installation cable is used, it can be connected with an LSA adapter via the RJ-45 plug to the RJ-45 female connector of the System Access Point.

Commissioning is always carried out via the System Access Point. A smartphone, tablet or PC is required for commissioning. No additional software is required. The use of the free-of-charge free@home app is recommended for commissioning via smartphone or tablet.

10 Notes

11 Index

A	
Actions	41
Actuators	82, 109
Allocating devices to rooms	32
Allocating links	97
Available covers	113
B	
Basic settings	27
Binary inputs	75
Blind actuators	84
Bus line	11
Button function	54
C	
Colour settings	98
Commissioning	23
Connection of the CAT wire	116
Control and display elements	88
Control elements	52
Covers for switch ranges	112
Creating a plan for devices	22
Creating the house structure	30
D	
Device Functions	91
Device plan master	117
Device versions	6
Dimming actuators	83
Displays	72, 101
E	
Establishing the connection to the System Access Point	23
Examples of possible actions	44
F	
FAQ and Tips	116
free@home App	5
Functional system extensions	94
G	
General settings in the System Access Point	89
H	
Heating actuators	85
Home network	5
I	
Identification	33, 86
Wireless devices	86
Installation	5
Installation of actuators	9, 13
Interference of radio signal	16
L	
LED as light for orientation	55
LED as status display	56
Lengths and distances of lines	11
Limits of performance	7
Linking sensors and actuators	36
List view	40
M	
Master reset	88
Mesh network	14
Mounting the System Access Point	116
Movement detector	64
myABB Living Space®	49
N	
Network functions	87
Notes	118
O	
Overview of Product Range	100
P	
Panels	47
Parameter settings	
Movement detector (sensor)	67
Movement detectors/switch actuators, 1gang	67
Philips Hue	99
RTC	71
Sensor unit, 1gang	63
Sensor unit, 2gang	63
Sensor/blind actuator, 1/1gang	61
Sensor/blind actuator, 2/1gang	62
Sensor/dimming actuator, 1/1gang	59
Sensor/dimming actuator, 2/1gang	60
Sensor/switch actuator, 1/1gang	57
Sensor/switch actuator, 2/1gang	58
Sensor/switch actuator, 2/2gang	58
Parameters	98
Parts of an action	42
Performance features	6
Philips Hue integration	94
Philips Hue	94
Philips Hue setup	94
Planning and Installation	8
Planning of the System Access Point	19
Power supply	8, 12
Prerequisites	23
R	
Room temperature controller	68
S	
Sensor/actuator units	105
Sensors	102
Sensors and control elements	52
Setup of the main menu	29
Setup of the working area	30
Specifying a name	35
Switch actuators	82
Switching options	37
System Access Point	8, 12, 86

Coupling with wireless devices	48	U	
System devices	100	User interface	5
System requirements	5	User rights	28
T		W	
Time control	37, 99	Weather station	79
Time diagram	43	Allocation	80
Time profiles	37	Links	81
Timeline	39	Wireless device	
Topology of line participants	10	Factory settings	48
Transmission range	15	Wireless system	
Twisted pair version	8	System features	13
Types of Devices	52	Wireless version	12

Philips and Hue are registered trademarks of Koninklijke Philips Electronics N.V.

Apple Store, iPhone, iPad, iPod touch and Apple Watch are registered trademarks of Apple Inc. in the USA and other countries.

Google Play (Store) and Android are registered trademarks of Google Inc.

FRITZ!Box is a registered trademark of AVM GmbH.

WiFi Scanner™ is a trademark of AccessAgility LLC.

Contact us

A member of the ABB Group

Busch-Jaeger Elektro GmbH

PO box
58505 Lüdenscheid

Freisenbergstraße 2
58513 Lüdenscheid

www.BUSCH-JAEGER.com

info.bje@de.abb.com

Central sales service:

Tel.: +49 2351 956-1600

Fax: +49 2351 956-1700

Notice

We reserve the right to make technical changes at all times as well as changes to the contents of this document without prior notice.

The detailed specifications agreed upon apply for orders. ABB accepts no responsibility for possible errors or incompleteness in this document.

We reserve all rights to this document and the topics and illustrations contained therein. The document and its contents, or extracts thereof, must not be reproduced, transmitted or reused by third parties without prior written consent by ABB.

Copyright© 2016 Busch-Jaeger Elektro GmbH
All rights reserved